

Operation and Maintenance Manual

Pre/Post-vacuum Class B Table-top Autoclave

Model Elara11

Cat. No. MAN205-0497002EN Rev. F

Manufactured by:

☒ Tuttnauer Co. Ltd., Har Tuv Industrial zone B P.O.Box 170, Beit Shemesh
9910101, Israel ☎ Tel: 972 2 9904611, ☎ Fax: 972 2 9904730

☒ Tuttnauer U.S.A. Co, Ltd. 25 Power Drive Hauppauge, NY, 11788, USA. ☎ Tel
(631) 737 4850, (800) 624 5836, ☎ Fax: (631) 737 0720



TABLE OF CONTENTS

PARAGRAPH	PAGE NO.
1. GENERAL	3
1.1. INCOMING INSPECTION	3
1.2. WARRANTY.....	3
1.3. WARRANTY STATEMENT	4
1.4. SAFETY INSTRUCTIONS	4
1.5. GENERAL INFORMATION	6
1.6. SAFETY FEATURES	6
1.7. OPERATING CONDITIONS	9
1.8. OVERALL DIMENSIONS.....	10
1.9. FRONT VIEW	11
1.10. REAR VIEW	12
1.11. SPECIFICATIONS.....	13
1.12. STEAM GENERATOR DATA.....	13
1.13. AUTOCLAVE ELECTRICAL DATA	14
1.14. UTILITIES	14
1.15. ENVIRONMENTAL EMISSION INFORMATION	14
1.16. CONSTRUCTION.....	14
1.17. SYMBOL DESCRIPTION	15
1.18. WATER QUALITY	16
1.19. DIRECTIVES AND STANDARDS	17
2. CONTROL PANEL	18
2.1. DESCRIPTION AND FUNCTIONS OF THE FRONT PANEL.....	19
2.2. VISUAL INFORMATION CENTER.....	19
2.3. THE CONTROL CENTER	20
2.4. DATA CENTER	21
2.5. DISPLAYED ERROR MESSAGES / SYMBOLS	21
2.6. DISPLAYED OPERATIONAL MESSAGES / SYMBOLS.....	22
3. EZVIEW SCREENS	24
3.1. SCREENS SHOWING A SUCCESSFULLY COMPLETED CYCLE.....	24
3.2. SCREENS SHOWING ABORTED CYCLES AFTER A COMPLETED STERILIZATION STAGE	25
3.3. SCREENS SHOWING A FAILED CYCLE BEFORE COMPLETING THE STERILIZATION STAGE:	26
4. STERILIZATION PROGRAMS	29
4.1. PROGRAM 1: UNWRAPPED INSTRUMENTS.....	31
4.2. PROGRAM 2: WRAPPED INSTRUMENTS	32
4.3. PROGRAM 3: UNWRAPPED DELICATE INSTRUMENTS	33
4.4. PROGRAM 4: WRAPPED DELICATE INSTRUMENTS	34
4.5. PROGRAM 5: CALIBRATION CYCLE	35
4.6. PROGRAM 6: EXTRA DRYING TIME	36
4.7. PROGRAM 7: VACUUM TEST	37
4.8. PROGRAM 8: BOWIE AND DICK.....	38
5. CHECKING AND CHANGING PARAMETERS AND OTHER DATA	39
5.1. QUICK OPTIONS DIRECTORY	40
5.2. MAIN MENU	48
5.3. CYCLE PARAMETERS FOR CUSTOM PROGRAMS	57
6. PRINTER	66
6.1. PRINTER OUTPUT	66

6.2.	PRINTER HANDLING	68
7.	INSTALLATION INSTRUCTION.....	71
7.1.	LIFTING AND CARRYING	71
7.2.	UNPACKING THE AUTOCLAVE	71
7.3.	PLACING	72
7.4.	ELECTRICAL	73
7.5.	SETUP	73
7.6.	FILLING THE MINERAL-FREE WATER RESERVOIR.	74
8.	PREPARATION BEFORE STERILIZATION	76
9.	OPERATING INSTRUCTIONS	80
9.1.	PRE-HEATING	80
9.2.	WASTE WATER RESERVOIR	81
9.3.	OPENING THE DOOR	81
9.4.	ADDING ADDITIONAL DRYING TIME.....	82
9.5.	LOADING	82
9.6.	CYCLE DESCRIPTION	84
9.7.	EXTRA DRYING TIME	85
9.8.	UNLOADING	85
10.	PREVENTIVE AND SCHEDULED MAINTENANCE	87
10.1.	DAILY BY THE OPERATOR.....	87
10.2.	WEEKLY BY THE OPERATOR	88
10.3.	PERIODICALLY BY THE OPERATOR	89
10.4.	DRAINING THE RESERVOIR.....	89
10.5.	REPLACING THE AIR FILTER	90
10.6.	REPLACING THE DOOR GASKET.....	92
10.7.	CHECKING THE SAFETY VALVE	94
10.8.	CLEANING WATER STRAINER	96
10.9.	EMERGENCY OPENING OF THE DOOR.....	97
11.	TROUBLESHOOTING	98
12.	SPARE PARTS LIST.....	103
13.	ACCESSORIES	103

1. GENERAL



Read the Operating Instructions carefully, before beginning any operation on the autoclave!

1.1. ***Incoming Inspection***

Upon receiving your Tuttnauer Autoclave, carefully inspect the outside of the shipping carton for signs of damage. If any damage to the carton is found, note the location with respect to the autoclave and check that area of the autoclave carefully once it is fully unpacked. Observe packing method and retain packing materials until the unit has been inspected. Mechanical inspection involves checking for signs of physical damage such as: scratched panel surfaces, broken knobs, etc.

If any damage is found, contact your dealer as soon as possible so that they can file a claim with the shipping carrier and also notify Tuttnauer.

All Tuttnauer products are carefully inspected prior to shipment and all reasonable precautions are taken in preparing them for shipment to assure safe arrival at their destination.

Note: Lifting and carrying should always be done by two people.

1.2. ***Warranty***

Tuttnauer warrants, from the date of purchase, all new Elara11 autoclave for a period of one full year, covering both parts and labor. This one-year warranty covers defects in materials and workmanship on every part in the autoclave except door gaskets and HEPA filters (they are considered wear items).

Tuttnauer warrants the chamber for a period of ten (10) years against defects in materials and workmanship.

This warranty does not include installation or operator instruction which are covered in this manual for your convenience or which can be provided by your dealer.

This warranty does not apply to any instrument that has been subjected to improper use or accident, nor shall it extend to autoclaves that have been repaired or altered outside the factory without prior authorization from Tuttnauer.

The warranty also does not include routine cleaning or preventive maintenance, to be performed according to instructions in Sec. 10 (Preventive and Scheduled Maintenance). Tuttnauer's obligation is limited to the repair or replacement of parts for the autoclave. No other warranties or obligations are expressed or implied.

The Autoclave should only be used in a manner described in this manual!

1.3. *Warranty Statement*

To activate the warranty, the registration card must be completed and mailed or faxed to Tuttnauer within fourteen (14) days of purchase or you may call our customer service department at the number listed below.

Products will only be received and accepted for repair from an authorized dealer and only with prior return authorization from Tuttnauer. All transportation charges to and from Tuttnauer must be paid by the owner of the autoclave. Tuttnauer will not accept COD shipments. If repairs are needed during the first 90 days after purchase of this autoclave and a local authorized service dealer is not available, Tuttnauer will arrange pick up of the unit at Tuttnauer's expense. This will be on an individually evaluated basis and **ONLY** with pre-approval.

Note: If you have any questions or there are any difficulties with this instrument and the solution is not covered in this manual, please contact your dealer or Tuttnauer USA Co. **Do not attempt to service this instrument yourself.**

Tuttnauer USA Co., Ltd., 25 Power Drive Hauppauge, NY 11788, USA

: (800) 624 5836, (631) 737 4850, Fax: (631) 737 0720 e-mail: info@tuttnauerUSA.com.

1.4. *Safety instructions*

The autoclave has unique characteristics. Please read and understand the operation instructions before first operation of the autoclave. This manual includes instructions and guidance provided by the manufacturer on: how to properly operate the autoclave, the door safety mechanism, the dangers involved in circumventing the safety features, how to ensure that the door is closed, and how to select a correct sterilization program.

Make sure that you know where the main power switch is located. Autoclave maintenance is crucial for the correct and efficient function of the device.

The daily B&D test, at the beginning of the working day, is part of the preventive maintenance plan, along with the annual validation of the sterilization processes that ensures appropriate sterilization conditions.

Never use the autoclave to sterilize liquids since it is not designed for that purpose.

Never use the autoclave to sterilize corrosive products, such as: acids, bases and phenols, volatile compounds or solutions such as

ethanol, methanol, chloroform or radioactive substances. Below are the operating instructions – safety instructions:

1. All autoclave users must receive training in proper usage from an experienced employee. Every new employee must undergo a training period under an experienced employee.
2. When sterilizing plastic materials, refer to the item manufacturer's information and make sure that the item can withstand the sterilization temperature. Plastic that melts in the chamber is liable to cause a great deal of damage.
3. On closing the device door, make sure it is properly locked before activating. Verify that the **DOOR OPEN**  symbol is no longer displayed on the screen.
4. When withdrawing trays, use the enclosed tray handle or wear heat resistant gloves.
5. The door is electronically locked and will not open unless the pressure in the chamber equals the atmospheric pressure (chamber pressure is displayed on the screen).
6. The door also remains locked if there is a cycle failure or the unit has no power.
7. Open the door slowly to allow steam to escape.
8. Once a month, ensure that the safety valve is operating, and once every 5 years a certified inspector must perform a chamber pressure safety test.
9. Make sure there are no leaks, breaks, blockages, whistles or strange noises.
10. Perform maintenance operations as instructed. The owner of the autoclave is responsible to perform the maintenance operations.
11. Notify the person in charge immediately of any deviation from the proper function of the device.
12. Protective equipment and clothes and other safety instructions should be implemented in accordance with local and national regulations and/or rules!
13. Before use, check inside the autoclave chamber to ensure that no items have been left from the previous cycle.
14. Load trays in such a way as to allow steam to move freely among all items.
15. Verify once again that you have chosen the appropriate sterilization program.
16. Individual glass bottles shall be placed on a tray

1.5. General Information

The Elara11 is a table-top autoclave designed for sterilization of medical and surgical goods such as unwrapped and wrapped, solid, hollow, porous products, tubes and related items found in ophthalmic, dental, medical, and veterinary clinics, first aid rooms, hospitals, laboratories etc.

This autoclave model is an electrically heated sterilizer using steam as a sterilizing agent.

The Elara11 is designed as Type B sterilizer in accordance with EN13060.

The Elara11 is a pre/post-vacuum sterilizer which uses vacuum pulse technology for removing air from the chamber at the beginning of the cycle and moisture from the instruments at the end of the cycle. **Drying is performed with the door closed**, using a combination of heat and vacuum.

The advantages of a pre/post-vacuum sterilizer are as follows:

- Removal of residual air from packs and porous load and most kinds of tubes (rubber, plastic etc.) by vacuum during the first stage of the cycle.
- More efficient steam penetration into the load; assuring effective sterilization.
- Improved temperature uniformity throughout the chamber.
- Better drying of materials due to the vacuum achieved in the chamber during the drying cycle.

1.6. Safety features

The following safety devices are installed in the autoclave to optimize safe operation and protect operating personnel.

- Two door switches that indicate that the chamber door is fully closed and latched. Without this indication steam is not introduced into the chamber.
- An electrical door locking pin that blocks door opening during operation.
- Two safety thermostats, to prevent over-heating of the steam generator and the chamber.
- Two safety pressure valves to prevent over-pressurizing the steam generator or the chamber.
- An advanced control system for monitoring and controlling the process.

The Elara11 offers a choice of the following automatic programs designed to match the material to be sterilized.

Program #	Program Name	Sterilization		Drying Time
		Temp	Time	
1	Unwrapped Instruments	273°F	4 min	1 min
2	Wrapped Instruments	273°F	4 min	20 min
3	Unwrapped Delicate Instruments	250°F	20 min	1 min
4	Wrapped Delicate Instruments	250°F	20 min	20 min
Test 1	Vacuum Test	N/A	Pre-set	
Test2	Bowie and Dick	273°F	3.5 min	2 min

The Elara11 is validated for use in sterilizing lumened devices of no longer than 230mm and no smaller than 3.4mm for sterilization programs 2 and 4.

The Elara11 is validated for use in sterilizing fabric packs/textiles for sterilization programs 2 and 4.

The Elara11 is validated for use in sterilizing up to six dental handpieces for sterilization programs 2 and 4.

A computerized control unit ensures a fully automatic sterilization cycle, control and monitoring of physical parameters and clear documentation of the sterilization cycle.

The Elara11 features a digital absolute pressure display which is used for monitoring and control purposes. The device is capable of displaying the pressure in psia, psig, kPa, Bar A or Bar G according to the operator's requirements. When the pressure is displayed in psig or Bar G, the atmospheric pressure is shown (at sea level) as 0 psig. If the pressure is defined in psia, Bar A or kPa the absolute zero is displayed as "0" and the atmospheric pressure is shown (at sea level) as 14.7 psia, 1 Bar A or 100 kPa respectively.

Note: This unit comes from the factory with the pressure parameter set to display in psig and the vacuum in inHg.

The Elara11 can display temperature in °F or °C.

Note: The unit comes from the factory set to display temperature in °F.

The control system is designed to meet the most current sterilization standards to ensure efficacy, safety of personnel and reliable operation.

A printer is standard on the autoclave. The printer prints the preset and actual parameters of the cycle (temperature, time and pressure).

The Elara11 also features built in memory to record up to 100 sterilization cycles. These can be reprinted on the printer or exported to a USB device to be transferred to a PC.

The Elara11 has a built in Network Port for use with Tuttnauer's R.PC.R software when connected to your local network.

The R.PC.R software has been developed especially for the Tuttnauer autoclaves.

This application will allow you to:

- Monitor up to 8 autoclaves
- Monitor the real time activity of any autoclave connected via the network port.
- Manage the history files of the cycles run on your autoclave.
- The history files can be downloaded either directly through a physical connection to the network port or transferred manually using a USB device.
- Store all the history of the processes that have been run on your autoclave
- Track the parameter setting that have been used in each of the cycles and stages run.
- Choose the style of the report to view; either graph, table, or a print out
- All reports can be saved as a PDF.
- The graph style report offers the user an option to customize the inputs and outputs used in the presentation.

For more information on the R.PC.R refer to the R.PC.R user guide.

This manual is intended for the user and gives the user a general understanding of the instrument and the best ways to operate and take care of it in order to obtain effective results.

Before operating this autoclave read carefully this operation manual.

After reading this manual, operating the autoclave will be easy.

However, since this instrument is built with high technology sensitive components, no attempt should be made by the user or any other unauthorized person to repair or recalibrate it.



Only technical personnel, of an authorized Tuttnauer dealer, having proper qualifications and holding technical documentation (including a technician manual) and adequate information are authorized to service the apparatus.

Read the Operating Instructions carefully, before beginning any operation on the autoclave!

1.7. *Operating Conditions*

This device is for indoor use only!

The minimum counter depth for the Elara11 is 24 inches.

Counter tops or slide-outs need to have a minimum capacity of 275 pounds.

The sterilizer should be loaded only with autoclavable material!

Minimum room ventilation shall be 10 cycles per hour.

The environment shall not exceed an ambient temperature range of from 41°F (5°C) to 104°F (40°C) and a relative humidity of 85%.

Operate the autoclave only in the manner specified in the manual. If the equipment is used in a manner not specified by the manufacturer, the protection provided by the equipment may be impaired.



CAUTION!

Waste water should be brought into the public net in accordance with the local rules or requirements

ONLY NON-HAZARDOUS LIQUIDS SHALL BE DISPOSED IN PUBLIC SEWAGE!

1.8. Overall Dimensions

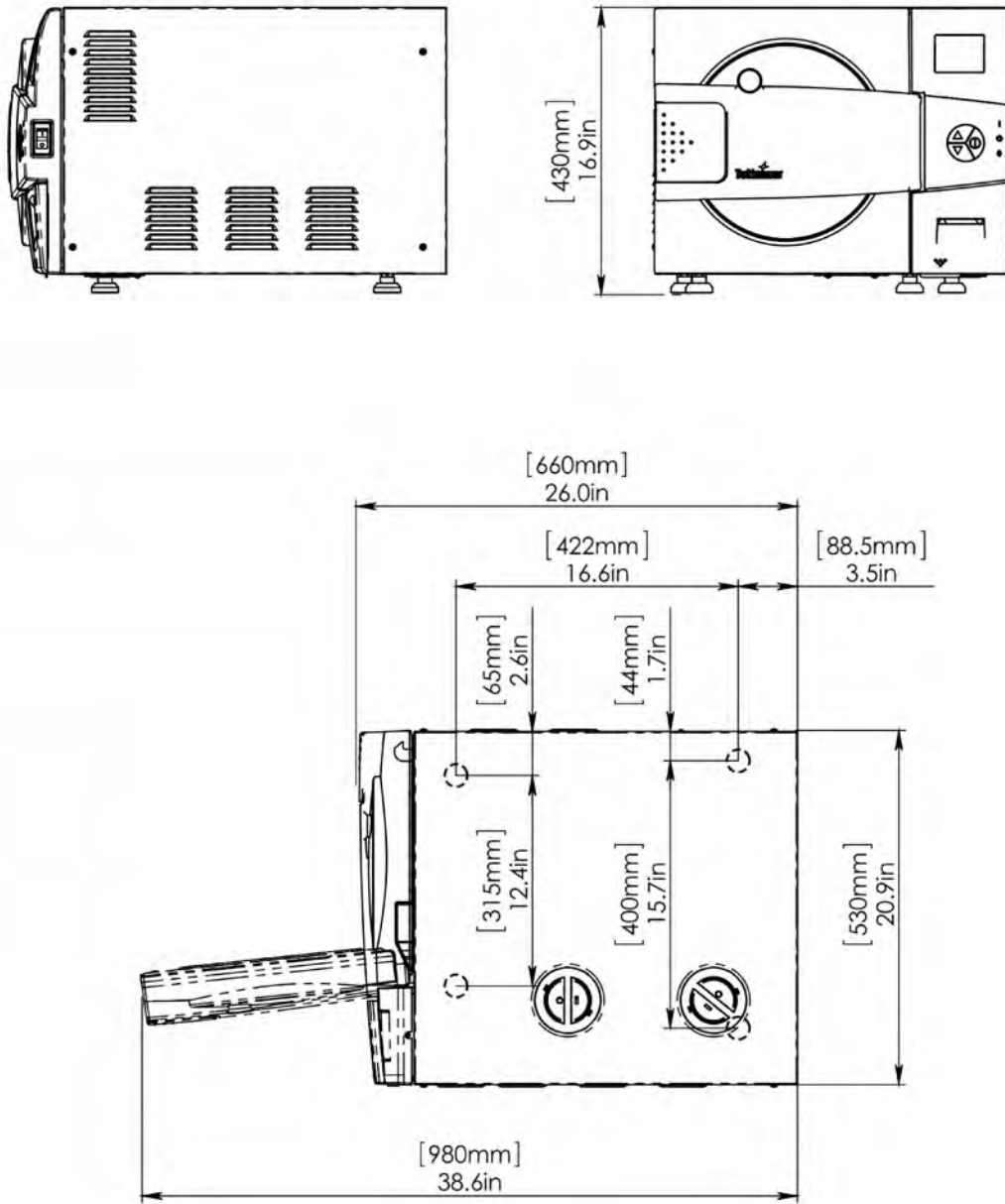

1.9. Front View

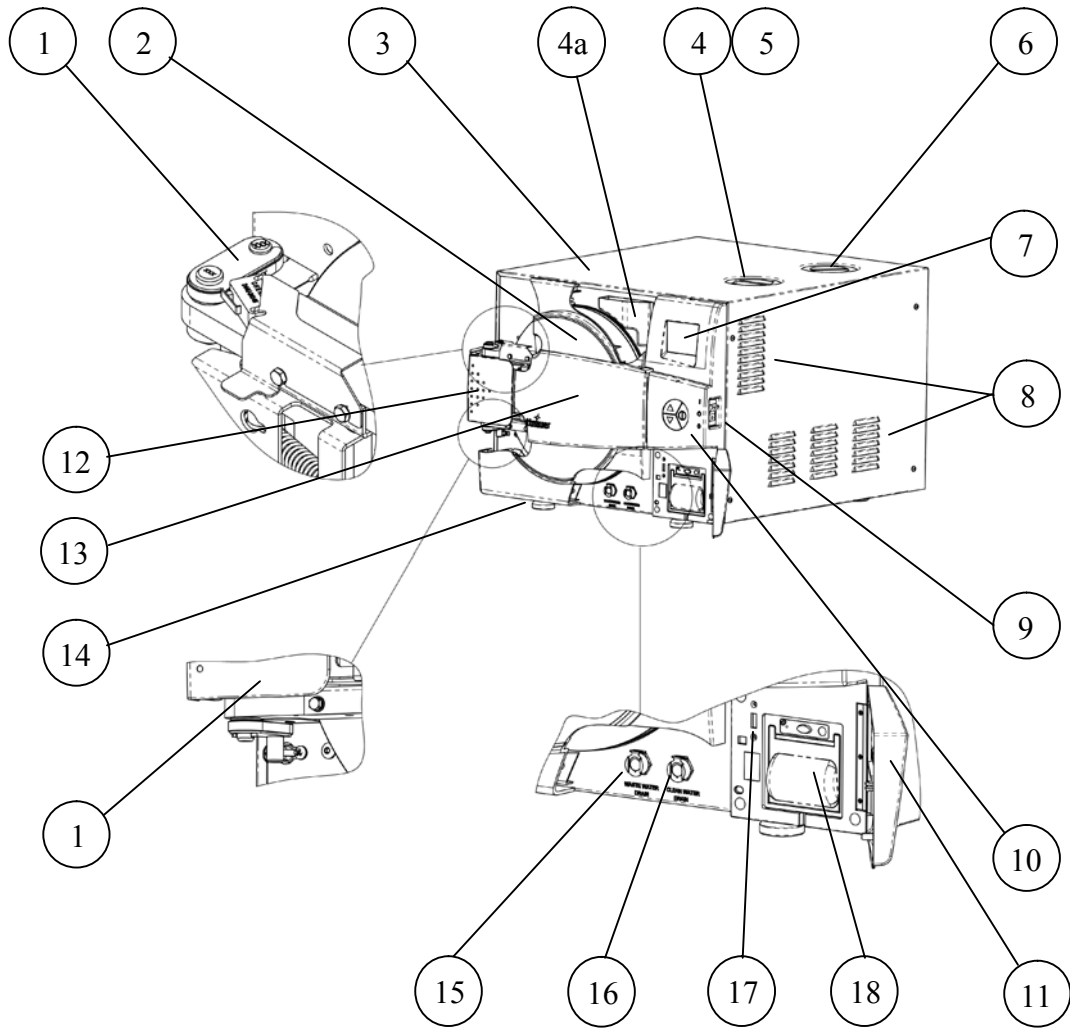

No.	Description	No.	Description
1	Door microswitches	10	EZPad Keypad
2	Autoclave door	11	Printer cover
3	Autoclave outer cover	12	Door opening grip
4	Mineral-free water reservoir	13	Plastic door cover
4a	Water reservoir fill and level gauge		
5	Chamber and steam generator safety valves (inside the reservoir)	14	Autoclave Leg
6	Waste water reservoir	15	Waste water drain
7	EZ View Display	16	Clean water drain
8	Ventilation grill	17	USB port
9	On/off switch / circuit breaker	18	Printer (standard)

1.10. Rear View

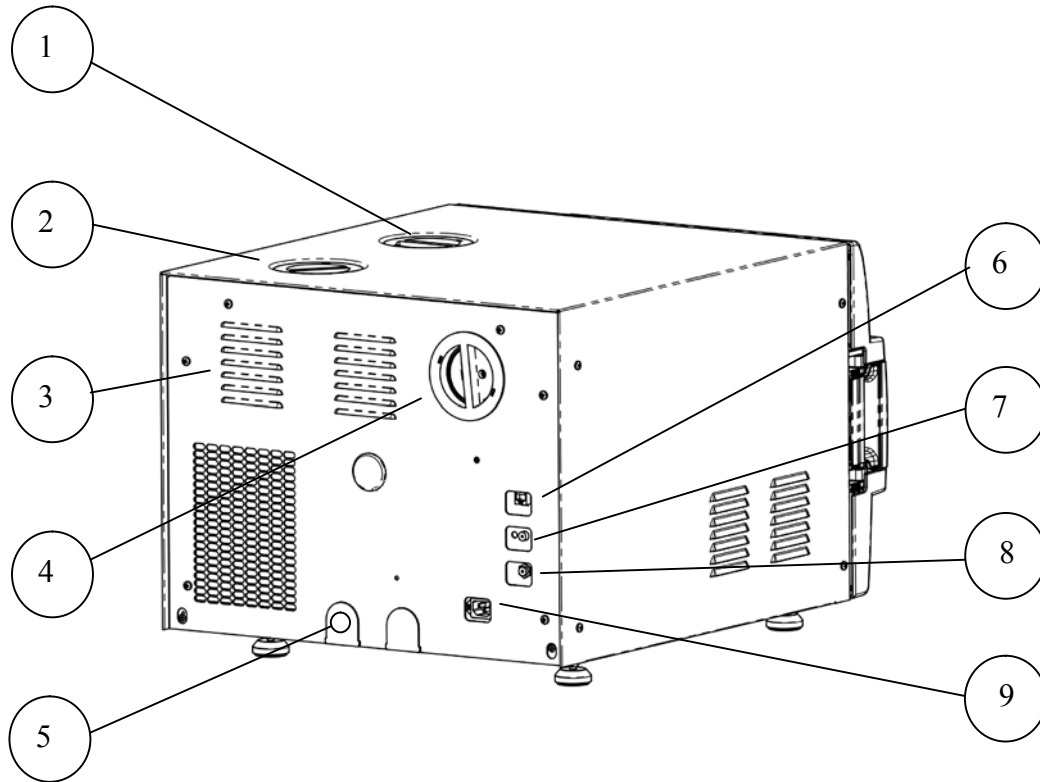

No.	Description	No.	Description
1	Mineral-free water reservoir	6	RJ45 network port
2	Waste water reservoir	7	Jacket cut-off thermostat
3	Ventilation grills	8	Generator cut-off thermostat
4	Air filter service cover	9	Main power electric cable socket
5	Waste water outlet to drain		

1.11. Specifications

Property		ELARA11
Shipping weight		171 lbs (78 kg)
Maximum weight with instruments full reservoirs and generator		194.89 lbs (88.4 kg)
Shipping dimensions (width/height/depth)		W 28.4" * L 32" * H 27.5" (W 72cm * L 81.2cm * H 70cm)
Shipping volume		14.47 cu ft. (0.41 cu m)
Support area capacity when fully loaded		275 lbs. (125 kg) minimum
Cassette capacity based on 8x11 and 8x5.5 Miltex Thompson cassettes		4 full and 4 half loaded vertically
Minimum counter depth		24" (610mm)
Chamber Diameter		11" (280mm)
Chamber Depth		19.8" (504mm)
Chamber volume		7.5 gal. (28.5 lit)
Max. Allowable Working Pressure (MAWP)		40 psi (2.8 bar)
Maximum instrument load per item		0.7 lbs. (0.3 kg)
Maximum instrument load per tray		3.5 lbs. (1.58 kg)
Maximum solid instrument load		17.6 lbs. (8.0 kg)
Maximum textile load		4.4 lbs. (2.0 kg)
Tray dimensions DxWxH		16.3" * 6.7" * 0.6" (442mm * 173mm * 19mm)
No. of trays		5
Weight		158 lbs. (71.7 kg)
Mineral-free water reservoir	Max. water volume	1.375 US gal (5.2 lit)
	Min. water volume	0.4 US gal (1.5 lit)
Used (waste) water reservoir	Max. water volume	0.9 US gal (3.41 lit)

1.12. Steam Generator Data

Property	Value
Max. working pressure	40 psi (2.8 bar)
Safety relief valve	40 psi (2.8 bar)

1.13. Autoclave Electrical Data

Property	Value
Total Power	2300W
Voltage	1 or 2 phase, / 230VAC ±5%, 60Hz
Amperage	10A
Protection against electrical shock	Class I (IEC 60601-1)
Mains supply fluctuation	+/- 5%
Frequency (Hz)	60Hz
Electrical Circuit	Dedicated electrical circuit
Recommended circuit breaker	15A

1.14. Utilities

Property	Value
Mineral free water	See table in 1.18
Power supply	* 1 or 2 phase, / 230VAC ±5%, 60Hz
Recommended circuit breaker	15A

* According to the local network.



Cautions!

In order to avoid any injury by electrical hazard, it is recommended that a ground fault protection device (GFCI) be installed in the electrical panel feeding the autoclave (local codes may make this mandatory).

The electrical network must comply with local rules or regulations.

Verify that there is an easy access to the main power switch and to the current leakage safety relay (GFCI). The voltage supplied to the device must comply with the label ± 5%.

1.15. Environmental Emission Information

- The peak sound level generated by the autoclave is 65dBa with background noise of 48 dBa.
- The total heat per hour transmitted by the autoclave is <200Wh.





1.16. Construction

The main parts of the autoclave are made of materials as indicated below:

- Chamber is built of stainless steel 316 L.

- Door is made of stainless steel 316.
- Trays are made of stainless steel 304.
- Water reservoir is made of polyethylene.
- Door handle and door cover are made of hard plastic material, which is safe to touch and thermo-insulated.

1.17. Symbol Description

Symbol	Meaning	Part Number	Location
	Pour distilled water into the reservoir through the opening on top of the autoclave until it reaches 1" below the bottom of the base of the safety valves	LAB048-0355	Near the mineral-free water reservoir cover
	Caution! Hot steam.	LAB048-0058	Near the safety valve
	Don't pour water into this reservoir.		Near the waste water reservoir cover
	Caution! Consult accompanying documents	LAB048-0024	Near the Power switch
PUSH TO RESET	Resetting the cut-off	LAB048-0018	Near the cut-off
	Protective Earth (Ground)	LAB048-0020	Near the on/off switch
	Caution: Hot surface	LAB048-0023	On the top cover above the door and on the rear cover above the water strainer

1.18. Water Quality

Physical characteristics and contaminants levels

The steam distilled or mineral-free water supplied to the autoclave should have the physical characteristics and maximum acceptable level of contaminants indicated in the table below:

Physical Characteristics and Maximum acceptable contaminants levels in steam for sterilizers (According to EN 13060:2004).	
Element	Condensate – allowable content
Silicon dioxide. SiO ₂	≤0.1 mg/kg
Iron	≤0.1 mg/kg
Cadmium	≤0.005 mg/kg
Lead	≤ 0.05 mg/kg
Rest of metals except iron, cadmium, lead	≤0.1 mg/kg
Chloride (Cl)	≤0.1 mg/kg
Phosphate (P ₂ O ₅)	≤0.1 mg/kg
Conductivity at 68°F (20°C)	≤3 µs/cm
pH value (degree of acidity)	5 to 7
Appearance	Colorless clean without sediment
Hardness (Σ Ions of alkaline earth)	≤0.02 mmol/l

Compliance with the above data should be tested in accordance with acknowledged analytical methods, by an authorized laboratory.

Note:

We recommend testing the water quality once a month. The use of water for autoclaves that does not comply with the table above may have severe impact on the working life of the sterilizer and can invalidate the manufacturer's guarantee.

Note:

When purchasing distilled water, the label must say "Steam Distilled".

1.19. Directives and Standards

Every autoclave meets the provisions of the following Directives and is in compliance with the following Standards:

Technical Directives

- Medical Device Directive 93/42/EEC.
- Pressure Equipment Directive 97/23/EEC.

Technical Standards

USA Standards:

- ANSI/AAMI ST55:2010
- ASME Sec. VIII. Div 1
- UL 61010-1
- UL 61010-2-040
- FDA 510(K) Cleared
- ISO 17665-1:2006
- The Quality System complies with ISO 13485:2003 and ISO 9001:2008

Canada Standards:

- CMDR

Quality standards

The manufacturing plant meets the following quality standards:

- EN ISO 9001:2008 – Quality System.
- ISO 13485:2003 – Quality systems – Medical devices.
- The manufacturer retains all supporting documentation.

2. CONTROL PANEL

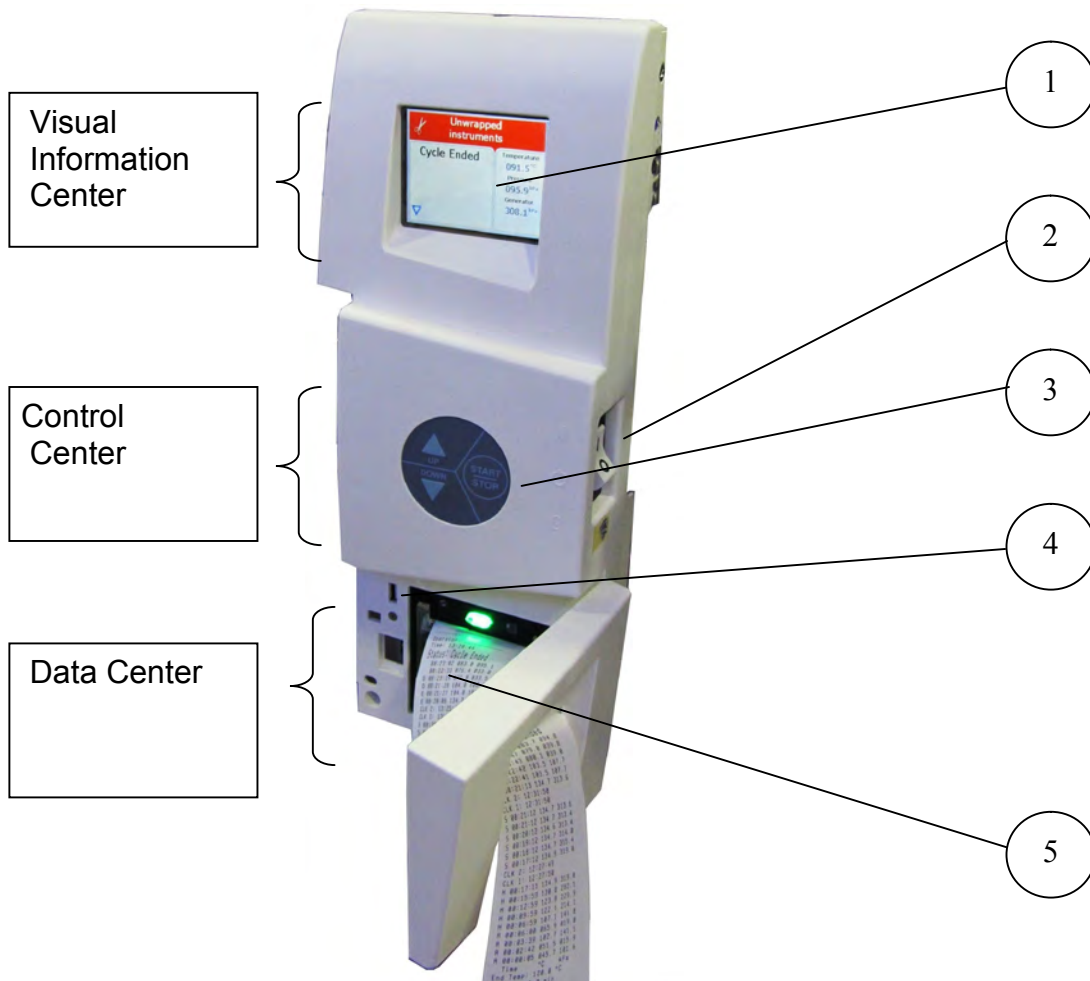

No.	Description
1	EZView Display
2	On/off switch and circuit breaker
3	EZPad Keypad
4	USB Port
5	Printer (Standard)

2.1. **Description and Functions of the Front Panel**

The front panel is composed of 3 sections (see picture on previous page):

1. Visual Information Center
2. Control Center.
3. Data Center

2.2. **Visual Information Center**

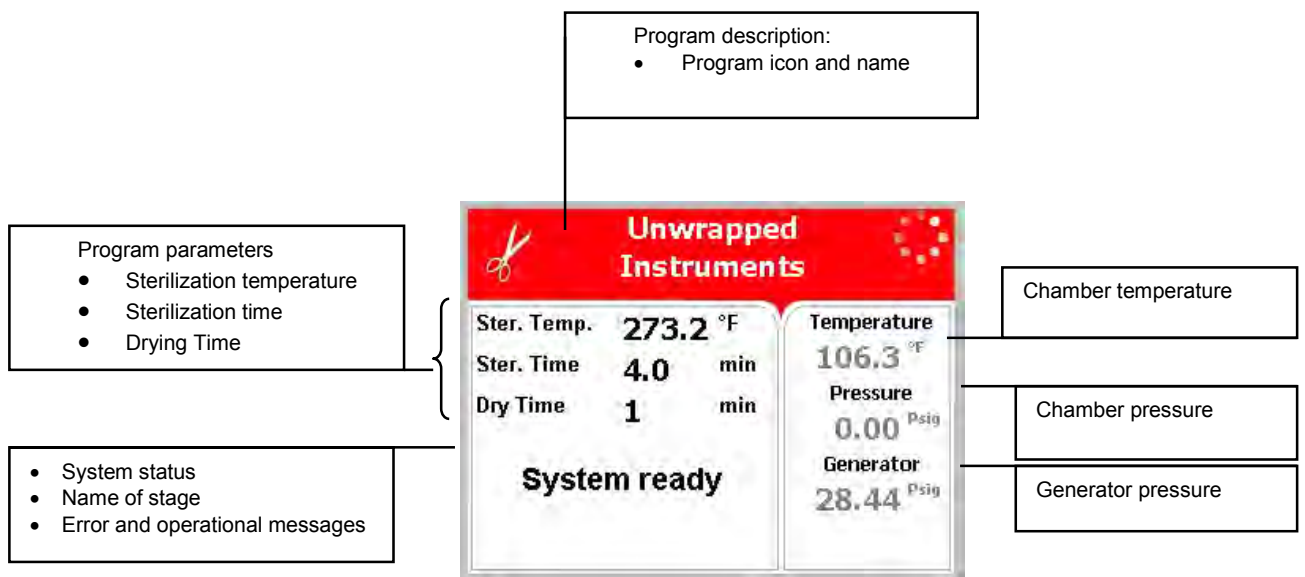

The information center contains the EZView display which is an LCD panel used to display the current status of the autoclave and any Operational Messages or Error Messages.



2.3. The Control Center

The Control Center contains the ON/OFF switch/Circuit Breaker and the Keypad

The keypad consists of 3 keys as described below:

	<p>UP key This key has the following functions:</p> <ul style="list-style-type: none"> • In the main screen: <ul style="list-style-type: none"> ○ This key enables the operator to browse through the cycles. • In the menu directories: <ul style="list-style-type: none"> ○ When the cursor is blinking on a number, the UP ▲ key increases its value. ○ When the cursor is blinking on a menu selection, the UP ▲ key allows browsing backward through the menu. ○ When adjusting a parameter and the cursor is blinking on “SET” or “EXIT” the UP ▲ key activates that procedure.
	<p>DOWN key This key has the following functions:</p> <ul style="list-style-type: none"> • In the main screen: <ul style="list-style-type: none"> ○ This key enables the operator to browse through the cycles. • In the menu directories: <ul style="list-style-type: none"> ○ When the cursor is blinking on a number, the DOWN ▼ key decreases its value. When the cursor is blinking on a menu selection, the DOWN ▼ key allows browsing forward through the menu. When adjusting a parameter and the cursor is blinking on “SET” or “EXIT” the DOWN ▼ key activates that procedure.
	<p>START/STOP key This key has the following functions:</p> <ul style="list-style-type: none"> • In the main screen: <ul style="list-style-type: none"> ○ Starts the process when the required program was chosen. ○ Stops the current process. ○ Cancels the ERROR message displayed on the screen. • In the menu directories: <ul style="list-style-type: none"> ○ When the cursor is blinking on a number, the START/STOP ⓘ key enables moving to the next position. ○ When the cursor is blinking on a menu selection, the START/STOP ⓘ key activates that selection.

2.4. Data Center

The Data Center contains a USB port, a network port and a printer.

- The USB port can be used to upload or download software and settings and download cycle history for transferring to a PC for storage or printing. The USB drive must be FAT formatted.
- The network port (located on the rear of the unit) can be used to connect to a local network and download information to Tuttnauer's R.PC.R software.
The RPCR software has been developed especially for the Tuttnauer autoclaves and is an excellent report generating tool.

This software will allow you to:

- Monitor up to 8 autoclaves
- Monitor the real time activity of any autoclave connected via the network port.
- Manage the history files of the cycles run on your autoclave. The history files can be downloaded either directly through a physical connection to the network port or transferred manually using a USB device.
- Store all the history of the processes that have been run on your autoclave
- Track the parameter settings that have been used in each of the cycles and stages run.
- Choose the style of the report to view; either graph, table, or a print out
- All reports can be saved as a PDF.
- The graph style report offers the user an option to customize the inputs and outputs used in the presentation.

For more information on the R.PC.R refer to the R.PC.R user guide.





- The printer comes standard on the machine. It prints the detailed history of each cycle performed by the autoclave. The printing is on thermal paper with 24 characters per line and records the sterilization cycle information for subsequent consideration.



2.5. Displayed Error Messages / Symbols

An error message is displayed when a failure occurs
The failures are divided into two categories:

- Failures that occur before completing the sterilization stage, which in this case will leave the load unsterilized
- Failures that occur after completing the sterilization stage, which in this case will leave the load sterilized
For the list of Displayed Error Messages / Symbols, see section 2.6 below.

2.6. *Displayed Operational Messages / Symbols*

Message / Symbol Name	Message / Symbol Description	Required Action
	This symbol is displayed when the door is open.	Close the door.
"Door is open"	This message is displayed in stand-by when the door is opened and START/STOP is pressed.	Close the door to perform a new cycle. If the problem persists, call for service.
"Cycle Ended"	This message is displayed when the cycle has ended successfully.	Open the door. The Instruments are ready to be removed.
"Test Ended"	This message is displayed when the test cycle has ended successfully.	Open the door and select the next cycle to run.
	This symbol is displayed when Cycle by Clock mode is active.	Enter the Quick Options menu as described in this manual to change the time or to cancel this option.
"Start cycle by clock is active"	This message is displayed if the user presses START/STOP key while the "start cycle by clock" mode is active. Starting another cycle is not allowed.	Enter the Quick Options menu as described in this manual to change the time or to cancel this option.
"Atmospheric pressure not set"	This message is displayed when the ATM needs to be set.	Turn the autoclave off then on. Open the door for 2 minutes this will automatically allow the Atmospheric pressure to be set. The chamber temperature must be below 113°F.
	This symbol is displayed and the cycle will not start if the temperature in the jacket has not reached the preset value.	Wait until the temperature in the jacket reaches the preset value
	This symbol is displayed when there is no water in the mineral-free water reservoir.	Pour water in the front funnel until it reaches the full level.

	<p>This symbol is displayed when the waste water reservoir is full.</p>	<p>Drain the waste water reservoir by plugging the included drain tube into the waste water drain. (see front view)</p>
	<p>This symbol is displayed and the cycle will not start if the steam pressure in the generator has not reached the required pressure.</p>	<p>Wait until the pressure in the generator reaches the required pressure.</p>

3. EZView SCREENS

During the cycle the EZView screen will change to let you know how the cycle is progressing. The following screens are a representation of what will be seen during a cycle.

3.1. Screens showing a successfully completed cycle

1. System Ready

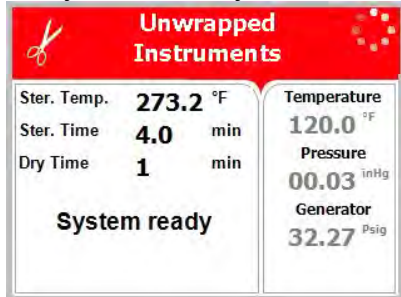

2. Starting

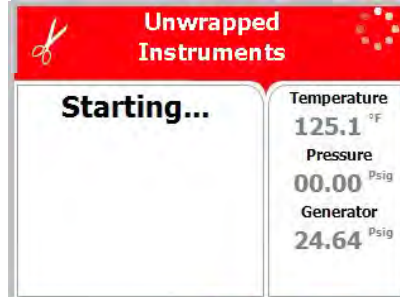

3. Pulse L

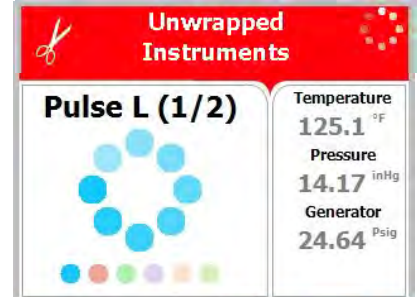

4. Pulse H

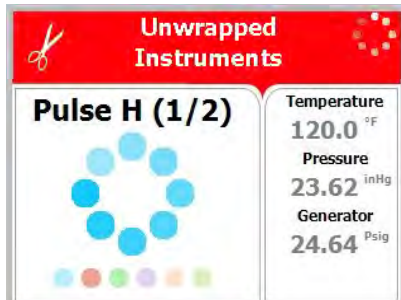

5. Heating

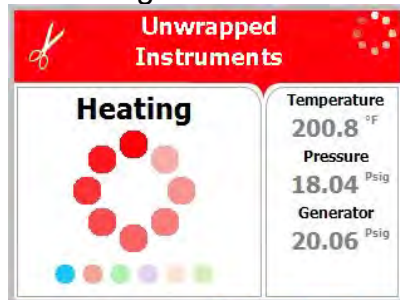

6. Sterilization

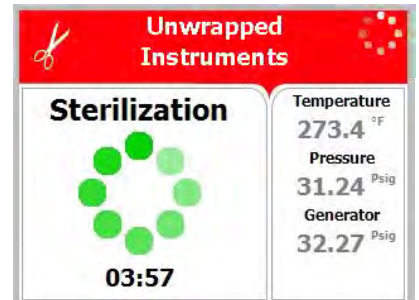

7. Exhaust

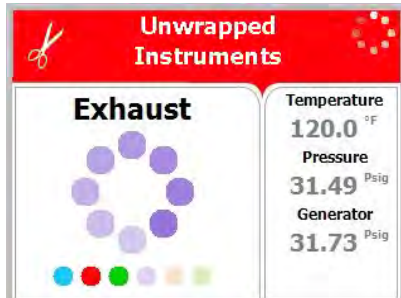

8. Drying

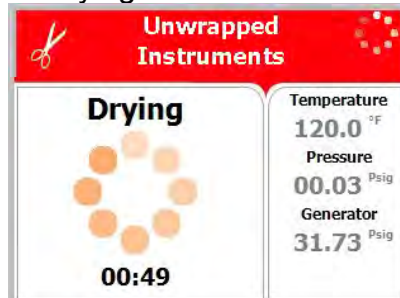

9. Ending

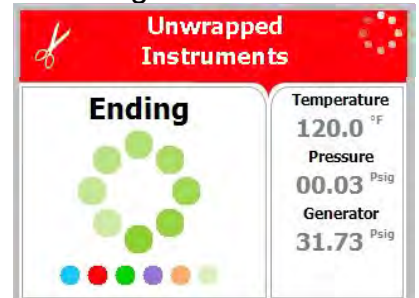

10. Cycle Ended (successful cycle)



3.2. Screens showing aborted cycles AFTER a completed sterilization stage

The sterilization phase ended successfully – the cycle was aborted and the reason for the failure is displayed. When the sterilization portion of the cycle is successful the EZView display remains white even though the cycle was aborted.

Note: There is a mandatory 1 minute of drying at the end of any aborted cycle.

The next three scenarios show examples of possible error messages:

3.2.1. Canceled by user AFTER complete sterilization stage

The sterilization stage ended successfully, however the operator manually aborted the remainder of the cycle, by pressing the **START/STOP** key. This resulted in the following sequence of screens showing the reason for the aborted cycle.

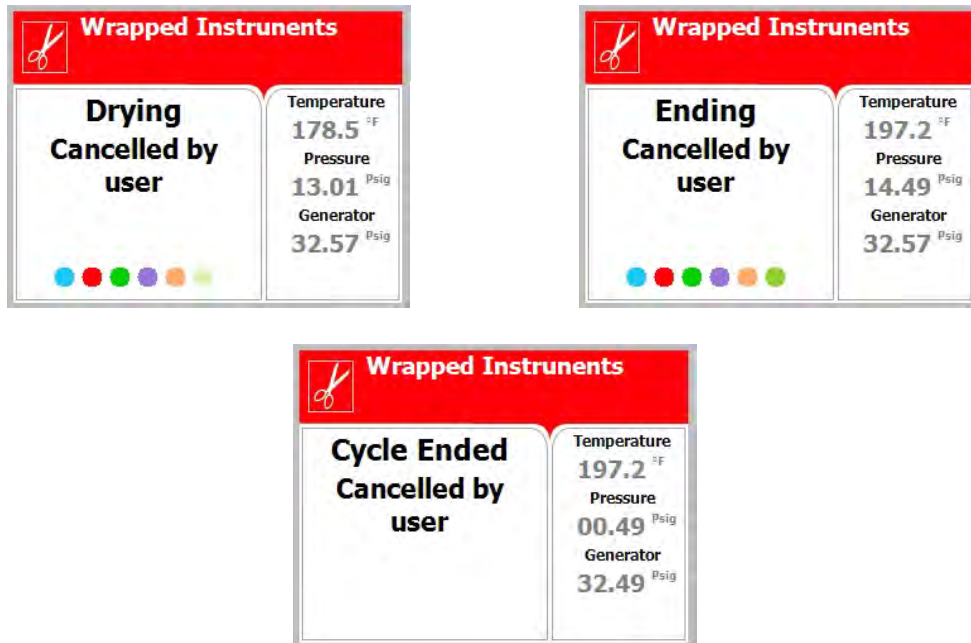

Note: The user will have to press the **START/STOP** key, after the mandatory 1-minute drying, to clear the message and unlock the door.

3.2.2. Door is open AFTER the sterilization stage has finished

The sterilization stage ended successfully, however the door switch indicated that the door was opened. This resulted in the following sequence of screens showing the reason for the aborted cycle.

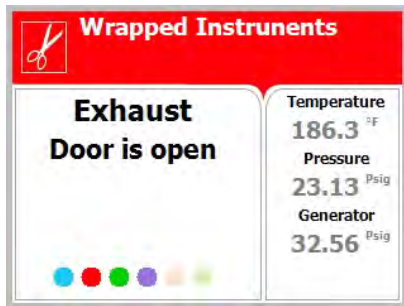

Note: The user will have to press the **START/STOP** key, after the mandatory 1 minute drying, to clear the message and unlock the door.

3.2.3. Screens showing a High Pressure Failure AFTER a completed sterilization stage

The sterilization stage ended successfully, however the chamber indicated that there was high pressure during the exhaust phase. This resulted in the following sequence of screens showing the reason for the aborted cycle.

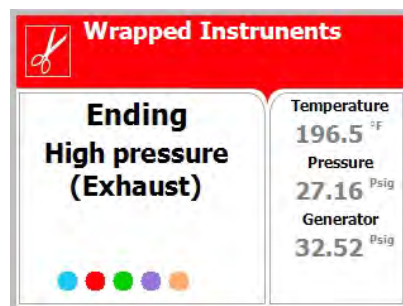
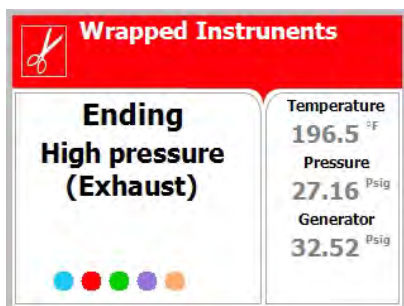

Note: The user will have to press the **START/STOP** key, after the mandatory 1 minute drying, to clear the message and unlock the door.

3.3. Screens showing a failed cycle BEFORE completing the sterilization stage:

When the machine fails **BEFORE** the sterilization phase is completed the EZView display becomes yellow, a warning sign  and the reason for the failure will appear.

Note: There is a mandatory 1 minute of drying at the end of any aborted cycle.

An explanation of how the EZView display screen will look when a cycle has failed:

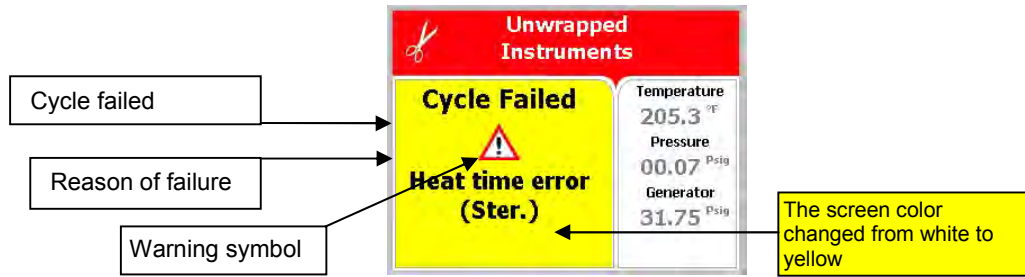

The next two scenarios show examples of possible error messages:

3.3.1. Screens showing a failure because of a Heat Time Error

The machine was not able reach the proper temperature. This resulted in the following sequence of screens showing the reason for the aborted cycle.

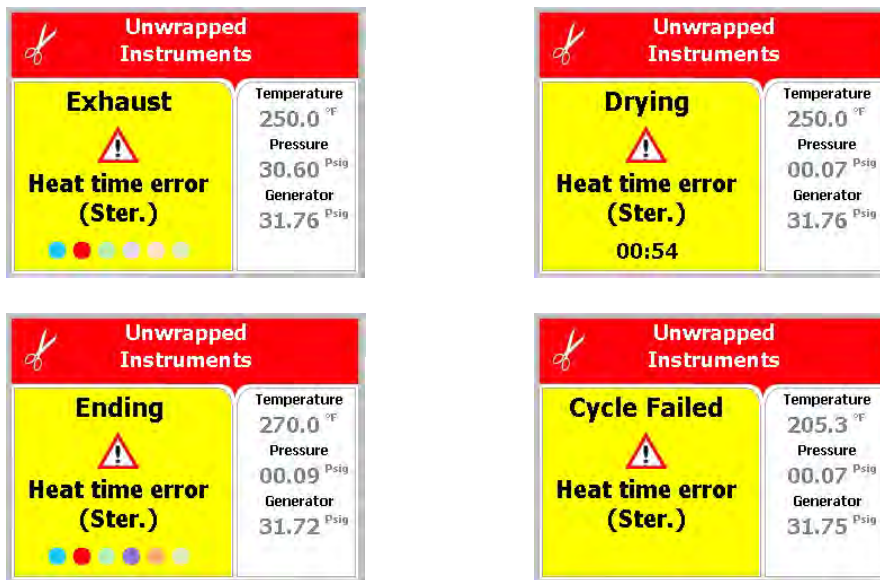

Note: The user will have to press the **START/STOP** key, after the mandatory 1 minute drying, to clear the message and unlock the door.

3.3.2. Failure due to Cancellation by user BEFORE completing the sterilization stage

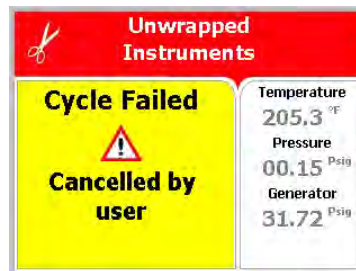

Note: The user will have to press the **START/STOP** key, after the mandatory 1 minute drying, to clear the message and unlock the door.

4. STERILIZATION PROGRAMS

The control system incorporates a safety feature that prevents changing programs if the door is closed.

This protection is intended to prevent running an inappropriate program if the autoclave is loaded, but the cycle is not immediately started.

If the operator for example inserts the load into the chamber, closes the door and leaves the room and another operator/user tries to change the program, the operator/user will not be able to do this unless the door is opened and the type of load inside the chamber can be seen.







The autoclave offers four preset FDA cleared sterilization programs, a calibration program (for use by a technician) an extra drying program a vacuum test program and a Bowie and Dick test program.

The FDA cleared program parameters are set and cannot be altered except to add additional drying time if needed.



Spore testing is your only assurance of complete sterilization.

Using the **UP OR DOWN** keys enables the user to select the various programs as seen in the following list:

Program	Icon	Name	Temp	Sterilizati on time (min.)	Dry time (minutes)
1		Unwrapped Instruments	273.2°F	4	1
2		Wrapped Instruments,	273.2°F	4	20
3		Unwrapped Delicate Instruments	249.8°F	20	1
4		Wrapped Delicate Instruments	249.8°F	20	20
5		Calibration Cycle	273.2°F	15	1
6		Extra Drying Time	---	---	5
7		Vacuum test		Vac. Time 1 = 5 Vac. Time 2 = 10	
8		Bowie and Dick	273.2°F	3.5	2

During the process, the various stages of the cycle will be displayed on the screen.

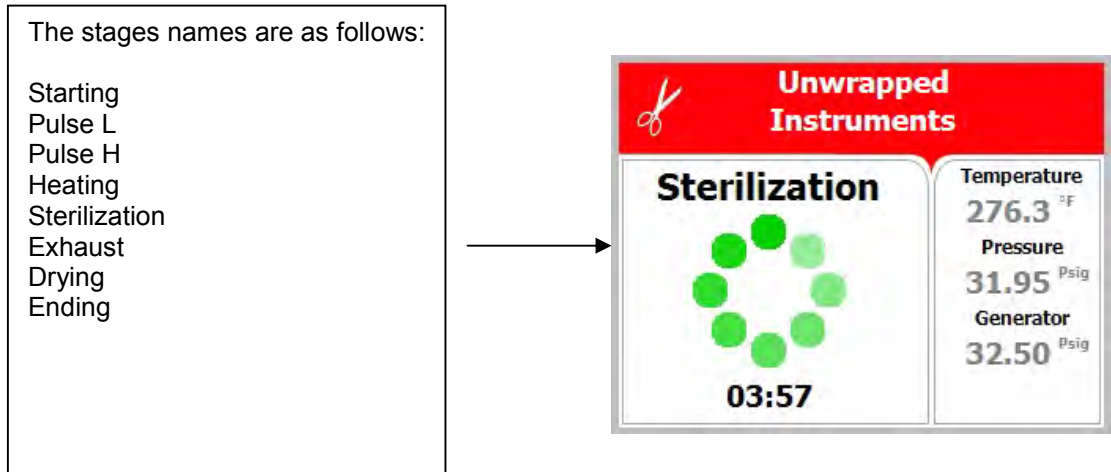

The user should use only those sterilizer accessories (Biological Indicators, Chemical Indicators, etc.) that have been cleared by the FDA for the specific cycle time and temperature of this device.

4.1. Program 1: Unwrapped Instruments

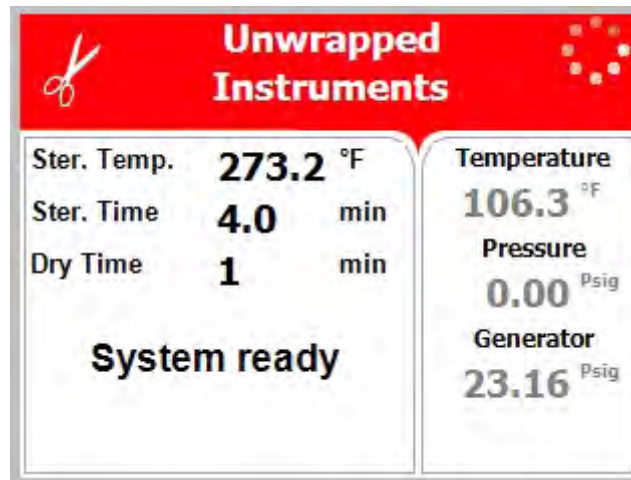

For unwrapped instruments and materials, when the instrument manufacturer recommends autoclaving at temperatures of 273.2°F (134°C) and no drying stage is required (1-minute drying is still required to remove residual steam from the chamber).

Nominal parameters default settings

Sterilization temperature: 273.2°F (134°C)

Sterilization time: 4 minutes.

Drying time: 1 minute (may be increased by the operator (see sec. 5.1.1), other parameters are set and cannot be altered).

Operations Sequence

- Air-removal stage: a series of vacuum pulses are performed.
- Heating stage: steam is injected into the chamber, from the steam generator, until the sterilization temperature is reached
- Sterilization phase: temperature and pressure are maintained constant at the pre-set level during the sterilization time.
- Fast exhaust: steam is exhausted out of the chamber at a fast rate until pressure decreases to ambient pressure.
- Drying for 1 minute to remove residual steam from the chamber.



CAUTION!

The sterility of instruments processed in unwrapped cycles cannot be maintained if exposed to non-sterile environment.

4.2. **Program 2: Wrapped Instruments**

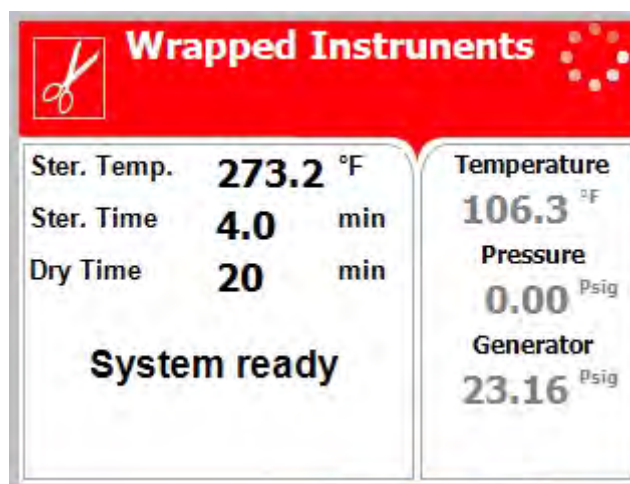

For wrapped instruments, pouches and materials, when the instrument manufacturer recommends autoclaving at temperatures of 273.2°F (134°C) with a drying stage.

Nominal parameters default settings

Sterilization temperature: 273.2°F (134°C)

Sterilization time: 4 minutes

Drying time: 20 minutes (may be increased by the operator (see sec. 5.1.1), other parameters are set and cannot be altered).

Operations sequence:

- Air-removal stage: a series of vacuum pulses are performed.
- Heating stage: steam is injected into the chamber, from the steam generator, until the sterilization temperature is reached
- Sterilization phase: temperature and pressure are maintained constant at the pre-set level during the sterilization time.
- Fast exhaust: steam is exhausted out of the chamber at a fast rate until pressure decreases to ambient pressure.
- Drying phase: a continuous vacuum along with heating of chamber to efficiently and quickly dry the instruments.
- Drying is followed by a vacuum break so chamber pressure can equalize to atmospheric pressure.

4.3. Program 3: Unwrapped Delicate Instruments

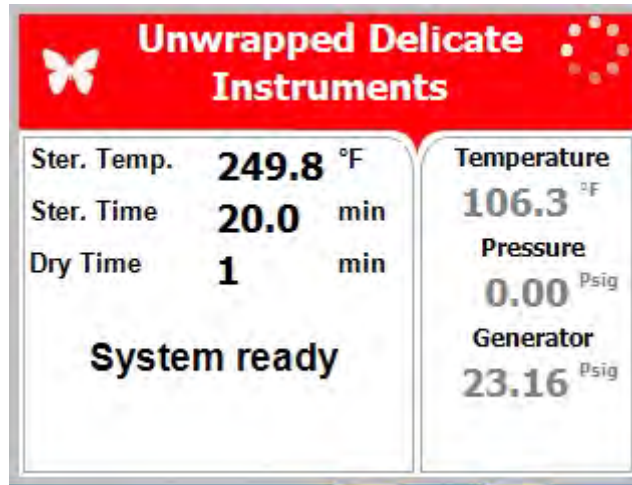

For unwrapped delicate instruments, when the instrument manufacturer recommends autoclaving at temperatures of 249.8°F (121°C) and no drying stage is required (1-minute drying is still required to remove residual steam from the chamber).

Nominal parameters default settings

Sterilization temperature: 249.8°F (121°C)

Sterilization time: 20 minutes.

Drying Time: 1 minute (may be increased by the operator (see sec. 5.1.1), other parameters are set and cannot be altered).

Operations sequence:

- Air-removal stage: a series of vacuum pulses are performed.
- Heating stage: steam is injected into the chamber, from the steam generator, until the sterilization temperature is reached
- Sterilization phase: temperature and pressure are maintained constant at the pre-set level during the sterilization time.
- Fast exhaust: steam is exhausted out of the chamber at a fast rate until pressure decreases to ambient pressure.
- Drying for 1 minute to remove residual steam from the chamber.



CAUTION!

The sterility of instruments processed in unwrapped cycles cannot be maintained if exposed to non-sterile environment.

4.4. **Program 4: Wrapped Delicate Instruments**

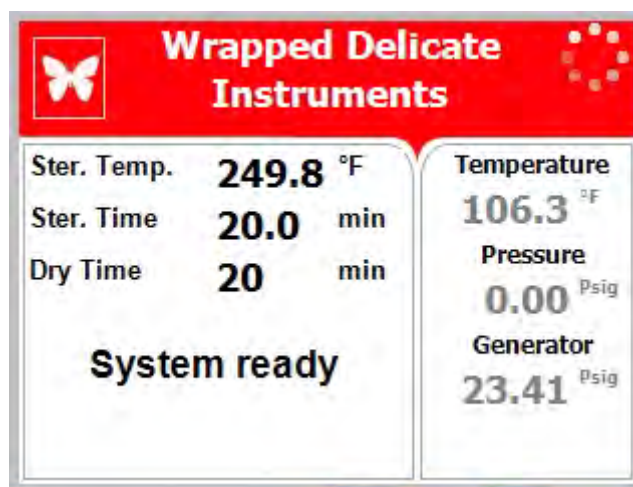

For wrapped Handpieces when the instrument manufacturer recommends autoclaving at temperatures of 249.8°F (121°C) with a drying stage.

Nominal parameters default settings

Sterilization temperature: 249.8°F (121°C).

Sterilization time: 20 minutes.

Drying time: 20 minutes (may be increased by the operator (see sec. 5.1.1), other parameters are set and cannot be altered).

Operations Sequence

- Air-removal stage: a series of vacuum pulses are performed.
- Heating stage: steam is injected into the chamber, from the steam generator, until the sterilization temperature is reached
- Sterilization phase: temperature and pressure are maintained constant at the pre-set level during the sterilization time.
- Fast exhaust: steam is exhausted out of the chamber at a fast rate until pressure decreases to ambient pressure.
- Drying phase: a continuous vacuum along with heating of the chamber to efficiently and quickly dry the instruments
- Drying is followed by a vacuum break so chamber pressure can equalize to atmospheric pressure

4.5. **Program 5: Calibration cycle**

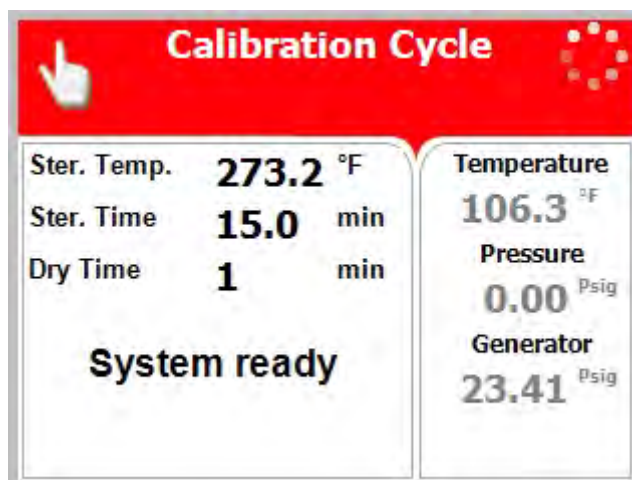

This program is only for use by a technician with the proper test equipment to aid in calibrating the autoclave. This is a shortened cycle with a long sterilization phase at 273.2°F (134°C) and no drying. (1-minute drying is still required to remove residual steam from the chamber).



CAUTION! This is not a sterilization program! This program has NOT been cleared by the FDA for sterilization.

Nominal parameters default settings

Calibration temperature: 273.2°F (134°C)

Calibration time: 15 minutes.

Drying time: 1 minute is the minimum value set when no drying is required.

Operations Sequence

- Air-removal stage: a series of vacuum pulses are performed.
- Heating stage: steam is injected into the chamber, from the steam generator, until the sterilization temperature is reached
- Sterilization phase: temperature and pressure are maintained constant at the pre-set level during the sterilization time.
- Fast exhaust: steam is exhausted out of the chamber at a fast rate until pressure decreases to ambient pressure.
- Drying for 1 minute to remove residual steam from the chamber.

4.6. Program 6: Extra Drying Time



For all loads, when the load requires additional drying after the cycle is completed.

Nominal parameters default settings

Drying time: 5 minute (may be changed by the operator (see sec. 5.1.1)).

Operations Sequence

Drying for 5 minutes.

4.7. **Program 7: Vacuum Test**

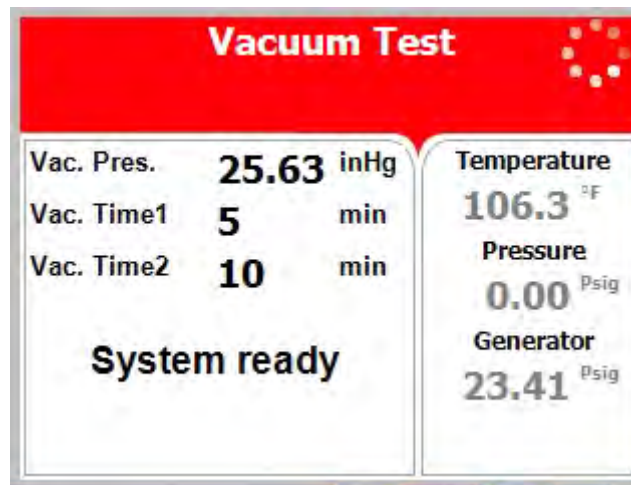

Vacuum is produced in the chamber, down to P1=2.47psi (0.17bar). At this stage all the valves close. The autoclave remains in this stage for 5 minutes. This period enables the condition in the chamber to reach equilibrium. After the 5 minutes have elapsed, the printer records the pressure that is referred to as P2. At this point the test begins and lasts 10 minutes. At the end of the test, the printer records the results. The pressure at the end of the test is referred to as P3.

Notes: During the test period the autoclave is not heated. During the test period the screen color is purple. If the vacuum test failed, the screen color changes from purple to yellow. If the vacuum test is completed, the screen color will remain purple. Even if the vacuum test is completed, the operator shall check the test results and consider whether the test results are acceptable or not.

4.8. **Program 8: Bowie and Dick**

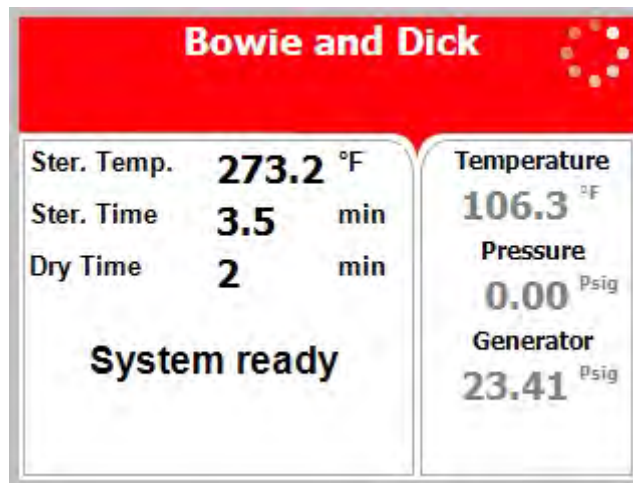

- Air-removal stage: a series of vacuum pulses are performed.
- Heating stage: steam is injected into the chamber, from the steam generator, until the sterilization temperature is reached
- Sterilization phase: temperature and pressure are maintained constant at the pre-set level during the sterilization time.
- Fast exhaust: steam is exhausted out of the chamber at a fast rate until pressure decreases to ambient pressure.
- Drying for 2 minutes to remove residual steam from the chamber.

If the B&D test cycle failed, the screen color changes from purple to yellow.

If the B&D test cycle ended successfully a "Test Ended" message will display and the screen color will remain purple.

5. CHECKING AND CHANGING PARAMETERS AND OTHER DATA

This section shows how to access system data and modify parameters.

The Cycle Parameters directory containing parameters for controlling the sterilization process is locked for programs 1 thru 4 and not available for modification from the default values (except for drying). Program 5 is a calibration program for use by a technician and all parameters are locked. Program 6 is an extra drying program for use by the operator if the load was not sufficiently dried. This program is open for adding additional drying time.

Programs 7 & 8 are test programs and all parameters are locked.

Spore testing is your only assurance of complete sterilization.

Once entering the programming mode, the operator will see and have access to the following directory items.

Directory		Subdirectory
Quick Options see sec. 5.1		Add extra dry time Export to USB Print cycles Version information Start cycle by clock Set date and time Login Exit
Main Menu (requires login) see sec. 5.2	Cycle Parameters – applicable only for Custom programs (except Dry Time) See sec. 5.2.1	Cycle Parameters
	System Parameters See sec. 5.2.2	Print Rate All
		Print Rate Sterilization
		Screen Saver
		Cycle Print Gap
	Maintenance See sec. 5.2.3	Auto Wake Up
		Reset atmospheric pressure
	Advanced Options See sec. 5.2.4	Printer test
Print all gain and offset		
	Set Temperature units	
	Set Pressure units	

5.1. Quick Options Directory

To take advantage of the system features it is necessary to access the programming mode. Some subdirectories enable the operator to see and change an individual cycle's parameters. Therefore, it is necessary to choose the required cycle before entering the programming mode.

1. Enter the **programming mode** by pressing the **UP** and **DOWN** keys **simultaneously** for 1-2 seconds. When released the "Quick Options" screen will be displayed. Scroll up or down the list and press the **START/STOP** key to select.

Some features will require an access code. The User's access code is 0001.



2. To exit this screen or any screen in this section, press the UP or DOWN key to move the cursor to Exit and press START/STOP key.

5.1.1. Add extra dry time

Accessing this parameter allows the operator to ADD additional drying time to the default drying time of the cycle selected.

As an example: If the program default is 30 minutes drying selecting 10 additional minutes will give a total drying time of 40 minutes. The additional drying time will remain as part of the cycle until changed back. To return to the original 30 minutes, select 0 additional minutes, now the total drying time will be 30 minutes.

Scroll up or down the list and press the **START/STOP** key to select.



5.1.2. Export to USB

Note: The USB flash drive needs to use FAT formatting.

Scroll up or down the list and press the **START/STOP** key to select.



1. Export current version to USB

Accessing the Export current version feature allows the operator to export the machines current application for evaluation by a technician.

- a. Insert the USB device into the USB Socket located behind the printer door (See Sec. 2.4)
- b. Move the cursor to Export current version to USB device.
- c. Press the **START/STOP** key

The following screen will be displayed:



2. Export all settings to USB

Accessing the Export all settings feature allows the operator to export all the machines cycle settings for evaluation by a technician using Tuttnauer's R.PC.R software.

- a. Insert the USB device into the USB Socket located behind the printer door (See Sec. 2.4)
- b. Move the cursor to Export all settings to USB device.
- c. Press the **START/STOP** key

The following screen will be displayed:



3. All cycle history
4. Last 10 cycles
5. Last 50 cycles

Accessing the export cycle history feature allows the operator to export cycle history of the previous 100 cycles to a USB device for evaluation or digital storage. Cycle data is exported in individual text file format (.txt) for viewing on a PC or with Tuttnauer's R.PC.R software. Exporting the cycle history will not automatically delete the cycle history.

- a. Insert the USB device into the USB socket located behind the printer door (see sec. 2.4)
- b. Move the cursor to select the number of cycles to export
- c. Press the **START/STOP** key.

The following screen will be displayed.



5.1.3. Print cycles

Select this option and the following screen will be displayed.

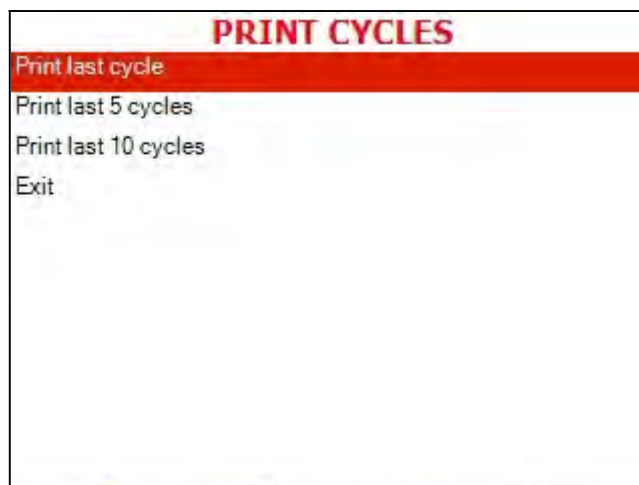

This subdirectory offers the following options:

- Print last cycle
- Print last 5 cycles
- Print last 10 cycles

This feature allows the operator to print out the last cycle, the last 5 cycles or the last 10 cycles. Scroll down to the desired option and press the **START/STOP** key. Once the printer has finished scroll to Exit and pressing the **START/STOP** key will return to the main screen

5.1.4. Version information

This subdirectory allows viewing of the current version of software running the machine.

Select this option and the following screen will be displayed.

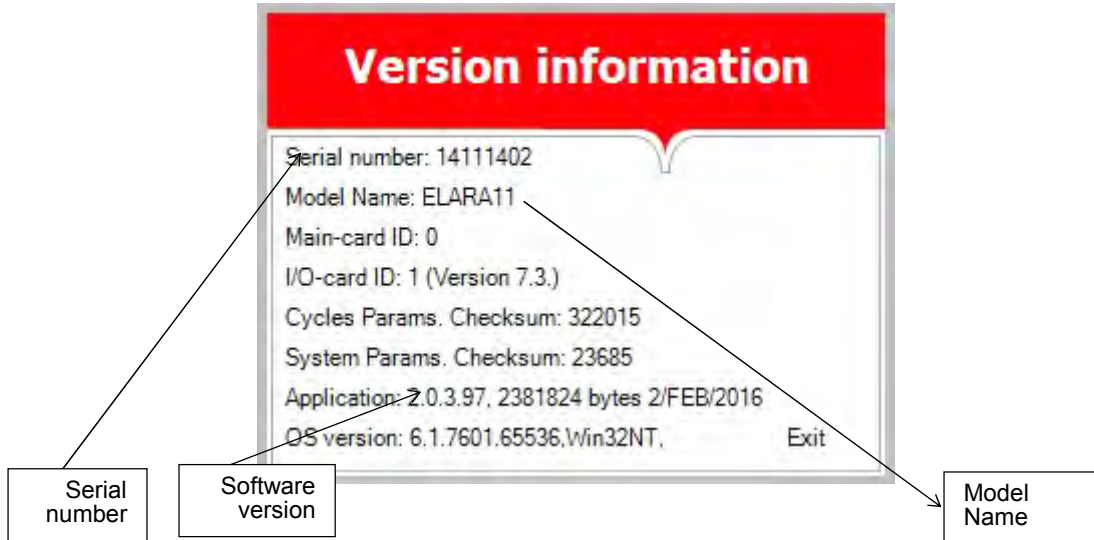

5.1.5. Start cycle by clock

This option allows for scheduling the selected cycle to start at a later time (The maximum possible delay is 24 hours). No other program can be run while the Start Cycle by Clock is active.

Select this option and the following screen will be displayed:



The time is displayed in the form "HH:MM". The time is in a 24 hour format (i.e. 14:30 = 2:30 PM).

Enabling the Start Cycle By Clock

1. Select the cycle to be scheduled from the Main Screen before enabling this option.
2. Set the start time by using the **UP** and **DOWN** keys to change the blinking digit. Use the **START/STOP** key to move to the next digit.
3. Use the **START/STOP** key to move the cursor to Enable.
4. Use the **UP** or **DOWN** key to select Enable.
5. Use the **START/STOP** key to move the cursor to exit.
6. Use the **UP** or **DOWN** key to exit.
7. The cycle is now enabled.

Note: When Start Cycle by clock is enabled this icon  will be displayed on the main screen.



Once the cycle has run the option will automatically return to disabled

Cancelling the Start Cycle By Clock

Select the Start Cycle by Clock option from the Quick Options menu.

1. Use the **START/STOP** key to move the cursor to Disable
2. Use the **UP** or **DOWN** key to select Disable
3. Use the **START/STOP** key to move the cursor to exit
4. Use the **UP** or **DOWN** key to exit.
5. The cycle is now disabled.



5.1.6. Set date and time

Note: It is important to set the date and time when setting up a new machine for the first time.

The internal battery is turned off for shipping. Setting the date and time will restart that battery.

Note: Failure to set the Date and Time will cause a Time Error and the unit will not run properly.

This option enables the operator to set the date and time. The following screen will be displayed:



The time is displayed in the upper row in the form “HH:MM”. The time is in a 24 hour format (i.e. 14:30 = 2:30 PM)

To set the time use the **UP** and **DOWN** keys to change the blinking digit. Use the **START/ STOP** key to move to the next digit.

The date is displayed in the lower row in the form “DD/MMM/YYYY” (e.g. 27/JUN/2012)

To set the date use the **UP** and **DOWN** keys to change the blinking digit. Use the **START/ STOP** key to move to the next digit.

When all changes are completed, use the **START/ STOP** key to move to **SET**, then use the **UP** or **DOWN** key to save the new date and time.

Setting the Date and time will cause the autoclave software to automatically reload.

5.1.7. Login

Accessing additional feature requires entering a password, follow these steps

1. Select Login and press the **START/STOP** key.
2. The SELECT USER screen is displayed



3. Move the cursor to User, if it is not already highlighted, and press START/STOP key
4. Enter Code screen is now displayed
5. 0000 is displayed on the screen with the cursor blinking on the right digit.

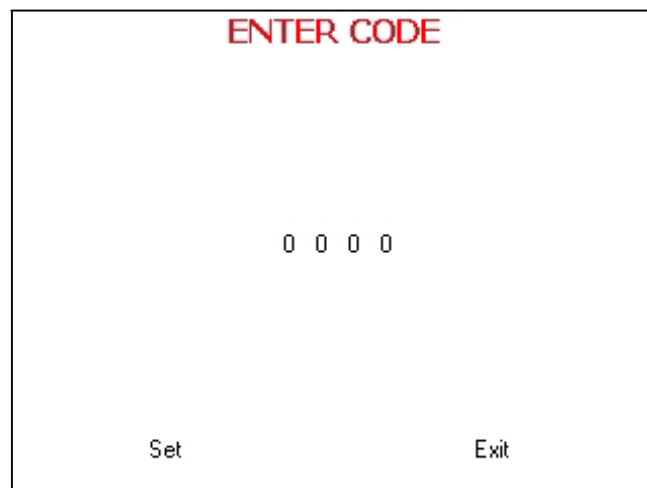

6. To increase or decrease the right digit, press the UP or DOWN keys.
7. Change the code to **0001** and move the cursor to SET by pressing the START/STOP key four times.
8. When SET is blinking, press the UP or DOWN key to enter the MAIN MENU screen.

The following screen is displayed:



See section 5.2 for more details on the MAIN MENU.

5.1.8. Exit

Selecting Exit and pressing the **START/STOP** key, will bring you back to the main screen.

5.2. Main Menu



1. To browse through the subdirectories, use the **UP** and **DOWN** keys.
2. When the desired directory is blinking, press the **START/STOP** key. The required screen (see the following paragraphs) will be displayed.
3. To exit the **MAIN MENU** screen, press the **UP** or **DOWN** key to move

- the cursor to **EXIT** and then press **START/STOP**.
- An explanation of the various directories, subdirectories and parameters can be found on the following pages.

5.2.1. Cycle Parameters

This directory allows for the modification of parameters for custom programs only, with the exception of the drying parameter in programs 1 thru 4 and 6 (see section 5.3). The drying parameter can only be increased from the default value.

5.2.2. System Parameters

This directory allows for the modification of five parameters. These parameters apply to all programs.

Print Rate all – defines the printing rate during all stages of the cycle except the sterilization stage. This feature requires a printer to be installed.

Print Rate Sterilization – defines the printing rate during the sterilization stage. This feature requires a printer to be installed.

Screen Saver – defines the time interval from the last use of the Keypad until the screen saver is activated. When the screen saver is on the machine is asleep. The door is locked and the heaters are off. Awaken the machine by pressing the Start/Stop key. The default time is 90 minutes. Setting this parameter to 0 minutes will disable the screen saver.

Cycle Print Gap – defines the number of blank lines to advance at the end of the cycle. This feature requires a printer to be installed.

Auto Wake Up – defines the time, within the next 24 hours, when the machine will automatically awaken from the Screen Saver (sleep) mode and unlock the door and start the heaters. This option is best used for warming up the machine before coming in the next day. This is only for use with custom cycles

To set the wake up time :

Entered the number of minutes counting from midnight until the machine is to wake up.

As an example, if you want to wake up the autoclave at 7:15 AM, set the parameter to 7 hours and 15 minutes as follows, $7 \times 60 \text{ minutes} + 15 \text{ minutes} = 435 \text{ minutes}$. When you set the Auto Wake Up value to 435, the autoclave will wake up every day at this time.

To deactivate this function, set the time value back to 0.

Modifying a system parameter

Every parameter can be changed as follows:

1. Select any program to modify the System Parameters
2. Enter the programming mode by pressing the **UP** and **DOWN** keys simultaneously for 1-2 seconds and then release.
3. Login using the User code **0001**



4. Select System Parameters from the Main Menu and press the **START/STOP** key.

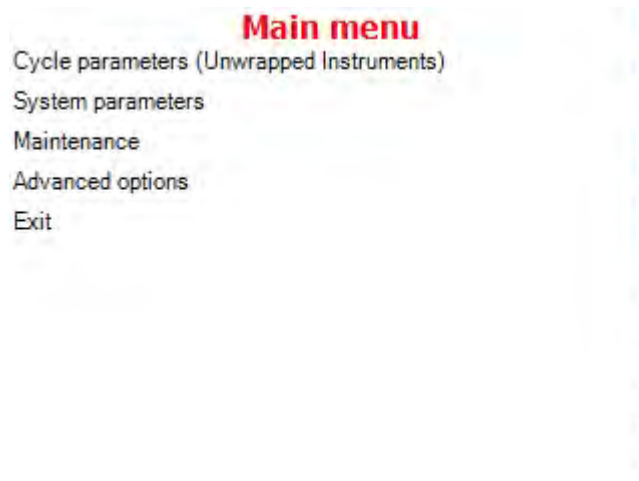

The System Parameters screen will appear.

System parameters	
Print Rate All	180 sec
Print Rate Sterilization	60 sec
Screen Saver	90 min
Cycle Print Gap	2
Auto Wake Up	0 min
Exit	

5. Use the UP or DOWN keys to move to the appropriate parameter from the system parameters screen
6. Use the **START/STOP** key to select this parameter. The set parameter screen will appear.

The Set parameter screen shows the name of the parameter to be changed; it shows the maximum, minimum, and default value for this parameter. It also shows the current parameter setting.

SET PARAMETER	
Max:	300 sec
Min:	1 sec
Default:	180 sec
Print Rate All	
	0 0 1 8 0 sec
Set	Exit

7. Use the **UP** and **DOWN** keys to change the desired value.
8. Use the **START/STOP** key to advance the blinking cursor to **SET**. Use **UP** or **DOWN** key to enter the new value.
9. Selecting **SET** or **EXIT** will return you to the previous screen where the next parameter can be selected for modification.
10. Selecting **EXIT** before selecting **SET** will return to the previous screen without changing the parameter.

5.2.3. Maintenance

Maintenance

Reset atmospheric pressure (00.00 Psig)
Printer test
Print all gain and offset
Exit

This directory offers the following three options. These options apply to all programs.

- Reset atmospheric pressure
- Printer test
- Print all gain and offset

Modifying a maintenance parameter

Maintenance

Reset atmospheric pressure (00.00 Psig)
Printer test
Print all gain and offset
Exit

1. Select any program from the Main Screen to access the Maintenance options.
2. Enter the programming mode by pressing the **UP** and **DOWN** keys simultaneously for 1-2 seconds and then release.
3. Login using the User code 0001
4. Select Maintenance from the Main Menu and press the **START/STOP** key.

The following screen will appear:

Maintenance

Reset atmospheric pressure (00.00 Psig)
Printer test
Print all gain and offset
Exit

5. Use the **UP** or **DOWN** keys to move to the appropriate option from the maintenance screen.
6. Use the **START/STOP** key to select this option. The screen for that option will appear (see the screens for each option in the following sections).

5.2.3.1. Reset atmospheric pressure

This is an option to manually reset the Atmospheric pressure parameter.

Note: The atmospheric pressure parameter is set automatically, however this parameter can be manually reset by using this option. In order to reset the atmospheric pressure, make sure the door is open and the chamber temperature is less than 113°F. Move the cursor to Reset atmospheric pressure then press the **START/STOP** key.

The following screen will be displayed:



In order to exit this screen, press the **START/ STOP** key.

5.2.3.2. Printer Test

This option enables the operator to test the printer

The printer will provide the following print out:

```
Leak
Internal error
Air detector
Purge time out
Bio filter time out
Emergency stop
VHP Timeout
Error close door
Error open door
High temp. (Ending)
Air error
High pressure (Ending)
High pressure (Dry)
High pressure (Exhaust)
High temp. (Cooling)
Low pressure (Cooling)
Time error
High temperature
Low temperature
High pressure
Low pressure
Heat time error (Ster.)
Heat time error (Keep)
Pressure time error
Vacuum time error
Heat time error
No water
Power down
I/O-card failed
Analog input error
Door is open
Canceled by user
Cycle errors:
248 = °
168 = ¿
Special Chars:
System vers.: 26254
Cycle vers.: 158645
I/O-card vers.: 7.3
Software vers.: 2.0.5.1
Time: 08:53:52
Date: 29/SEP/2014
POWER ON
Time: 18:54:39
Date: 28/SEP/2014
POWER OFF
-----
```

When the printer has finished, the following screen will be displayed:



In order to exit this screen, press the **START/STOP** key.

5.2.3.3. Print All Gain and Offset

This option allows for printing all the gain and offset values. This information is for use by a factory engineer.

The printer will provide gain and offset for the following:

- Chamber temperature
- Chamber pressure
- Chamber water level
- Mineral free water level
- Jacket temperature
- Generator pressure
- Generator water level



The following screen will be displayed:

In order to exit this screen, press the **START/ STOP** key.

5.2.4 Advanced Options

This directory offers the following two options. These options apply to all programs.

- Set Temperature Units – allows the selection of either °F or °C
- Set Pressure Units- allows the selection of either psig, psia, kPa, Bar A or Bar G

Modifying an advanced option parameter

1. Select any program from the Main Screen to access the advanced options.
2. Enter the programming mode by pressing the **UP** and **DOWN** keys simultaneously for 1-2 seconds and then release.
3. Login using the User code 0001
4. Select Advanced Options from the Main Menu and press the **START/STOP** key.

The following screen will appear:

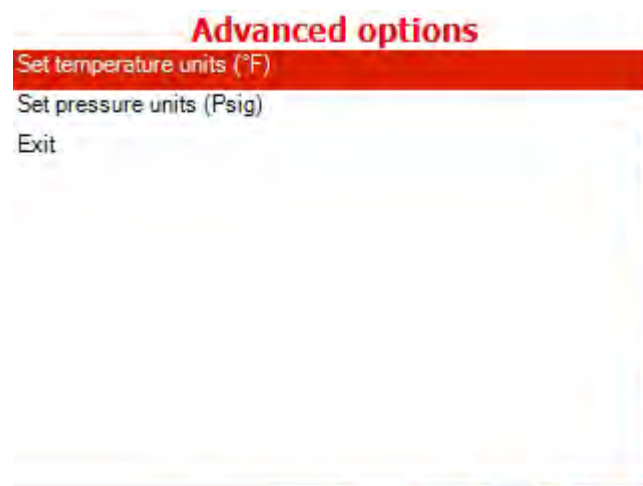

5. Use the **UP** or **DOWN** keys to move to the appropriate option.
6. Use the **START/STOP** key to select this option.
7. Use the **UP** or **DOWN** keys to scroll to the selection
8. Use the **START/STOP** key to make that selection
9. The system will automatically reboot.

5.3. **Cycle Parameters for Custom Programs**

The Elara11 offers the user the ability to create a custom program for any items where the preinstalled programs are not appropriate.

This directory enables the operator to see and change all the cycle parameters for that custom program.

The first step is to have your dealer or service technician create a custom program for you. Your dealer or technician can do this by duplicating one of the preinstalled programs. That new program becomes a custom program with a new name and parameters that you can change as needed.

To modify the parameters in a custom program, it is necessary to select that program from the Main Screen before entering the "**MAIN MENU**" directory

This directory includes seven subdirectories and the parameters that are associated with each. A description of each parameter can be found in section 5.3.2

Subdirectory	Property
Purge	Purge time
	Purge temperature
Create Pulse	Pulse A Count
	Pulse A Stay Time
	Pulse A Low Pressure
	Pulse A High Pressure
	Pulse B Count
	Pulse B Stay Time
	Pulse B Low Pressure
	Pulse B High Pressure
	Pulse C Count
	Pulse C Stay Time
	Pulse C Low Pressure
	Pulse C High Pressure
	Pulse D Count
	Pulse D Stay Time
	Pulse D Low Pressure
	Pulse D High Pressure
Heating	Sterilization Temperature
Sterilization	Sterilization Temperature
	Sterilization Time
Exhaust	Exhaust Mode

Drying	Dry Time
	Dry Heat On 1
	Dry Heat Off 1
	Dry first stage time
	Dry Heat On 2
	Dry Heat Off 2
	Additional Dry Time
Ending	End Temperature
Global	Jacket Temperature

5.3.1 Modifying a parameter for a Custom Program

In the following example one of the preinstalled programs was duplicated and it was named Custom A. The following instructions show how to modify one of the Custom A parameters, in this case Pulse A Count will be modified. These basic instructions apply to all the parameters.

1. Using the **UP** or **DOWN** keys to select the Custom A program from the Main Screen.

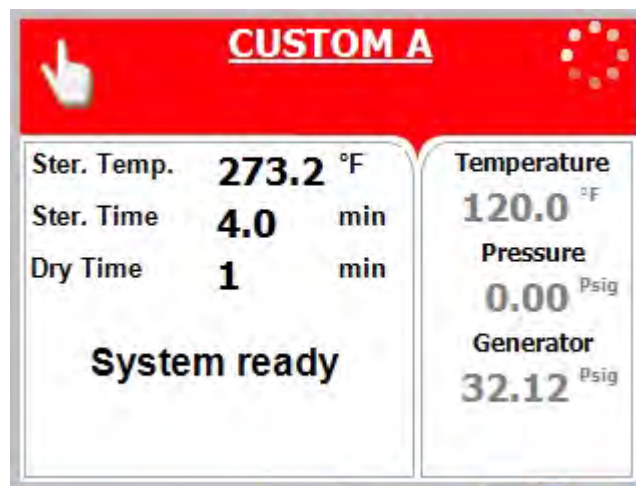

1. Enter the programming mode by pressing the **UP** and **DOWN** keys simultaneously for 1-2 seconds and then release.
2. Scroll to Login. Press the Start/Stop key to select
3. **User** will be flashing. Press the Start/Stop key to select



4. Login using the User code 0001.

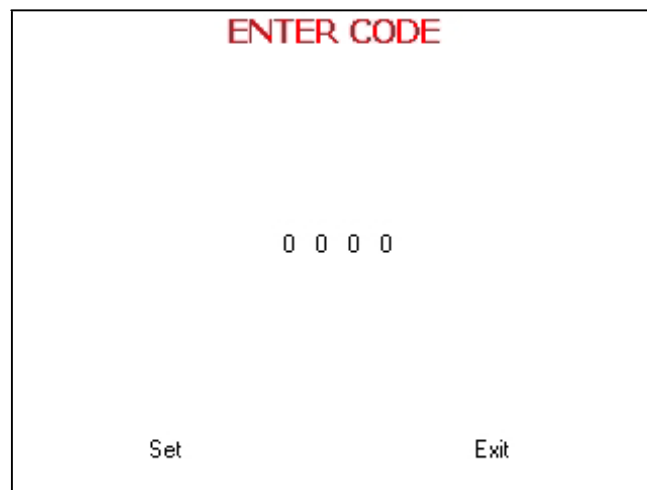

4. Select Cycle Parameters (Custom A) from the Main Menu.



5. Use the **UP** or **DOWN** keys to move to the Create Pulse subdirectory as shown in the table in sec. 5.3.2 Pressing the

START/STOP key will allow the user to enter that subdirectory.



6. Pressing the **START/STOP** key again will select the individual parameter for modification.
7. The Set Parameter screen will appear as shown with the current parameter setting highlighted.

This screen is representative of a typical Set Parameter screen.

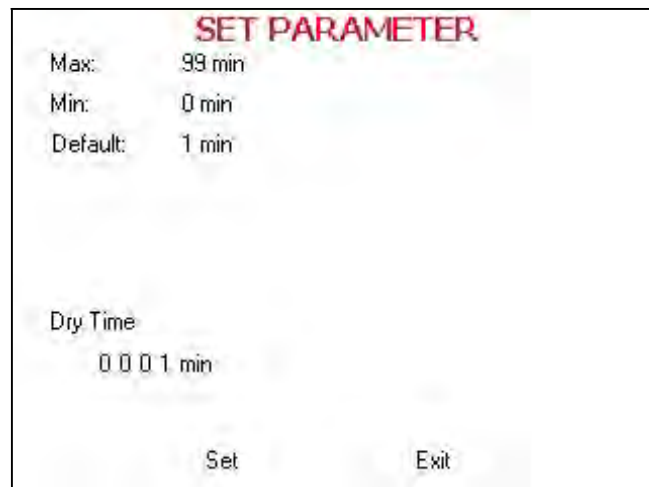

The Set Parameter screen shows the name of the parameter to be changed; it shows the maximum, minimum, and default values for this parameter. It also shows the current parameter setting.

8. Use the **UP** and **DOWN** keys to change the desired value. See the table in sec. 5.3.2 to determine the appropriate value to use.
9. Use the **START/STOP** key to advance the blinking cursor to **SET**. Use **UP** or **DOWN** key to enter the new value.
10. Selecting **SET** or **EXIT** will return you to the previous screen where the next parameter can be selected for modification.
11. Selecting **EXIT** before selecting **SET** will return to the previous screen

without changing the parameter.
The custom programs are not FDA cleared and it is the user's responsibility to validate any custom cycles



Spore testing is your only assurance of complete sterilization.

5.3.2 Table of Parameters

This option is only available for a Custom program.

This table describes the function of each of the parameters that control the different parts of the sterilization cycle. Each parameter is available for modification by the user.

The program to be modified must be selected before entering the **"MAIN MENU"** directory



**Custom programs are not FDA cleared.
 It is the user's responsibility to validate any Custom cycles.**

This device utilizes vacuum pulses for removing air from the chamber prior to sterilization. The Create Pulse parameters are what control this process. Inappropriate parameter modification can affect the quality of the sterilization process and the ability of the machine to complete that process.



Spore testing is your only assurance of complete sterilization.

Parameters	Subdirec	Description	Units	Range	Resolutio
Purge time		Time for the purge stage to last since the purge temperature has been achieved. Purge is a stage when steam is introduced into the chamber and exhaust is open in order to allow all residual air to be forced out by the steam.	Minutes	0-100	0.1

Purge temperature		Temperature at which purge stage can start.	°F	32-284°F	1°F
Pulse A Count	Create Pulse	Defines the number of pulses in the first pulse group (group A)	Whole Number	0-10	1
Pulse A Stay Time		Defines the additional time that the top exhaust valve will remain open after reaching the pressure set by the Pulse A low Pressure parameter in the first pulse group.	Seconds	1-100	1
Pulse A Low Pressure		Defines the pressure that the top exhaust valve closes at the bottom of each pulse.	Psia	0.73 – 43.51psia	.01
Pulse A High Pressure		Defines the pressure that the top exhaust valve opens at the top of each pulse.	Psia	0.73 – 43.51psia	.01
Pulse B Count		Defines the number of pulses in pulse group B.	Whole Number	0-10	1
Pulse B Stay Time		Defines the additional time that the top exhaust valve will remain open after reaching the pressure set by the Pulse B Low Pressure parameter in group B.	Seconds	1-100	1
Pulse B Low Pressure		Defines the pressure at which the top exhaust valve closes at the bottom of each pulse.	Psia	0.73 – 43.51psia	.01
Pulse B High Pressure		Defines the pressure at which the top exhaust valve opens at the top of each pulse.	Psia	0.73 – 43.51psia	.01
Pulse C Count	Create	Defines the number of pulses in pulse group C.	Whole Number	0-10	1

Pulse C Stay Time		Defines the additional time that the top exhaust valve will remain open after reaching the pressure set by the Pulse C low Pressure parameter in pulse group C.	Seconds	1-100	1
Pulse C Low Pressure		Defines the pressure that the top exhaust valve closes at the bottom of each pulse.	Psia	0.73 – 43.51psia	.01
Pulse C High Pressure		Defines the pressure that the top exhaust valve opens at the top of each pulse.	Psia	0.73 – 43.51psia	.01
Pulse D Count		Defines the number of pulses in pulse group D.	Whole Number	0-10	1
Pulse D Stay Time		Defines the additional time that the top exhaust valve will remain open after reaching the pressure set by the Pulse D Low Pressure parameter in pulse group D.	Seconds	1-100	1
Pulse D Low Pressure		Defines the pressure that the top exhaust valve closes at the bottom of each pulse.	Psia	0.73 – 43.51psia	.01
Pulse D High Pressure		Defines the pressure that the top exhaust valve opens at the top of each pulse.	Psia	0.73 – 43.51psia	.01
Sterilization Temperature	Heating	Defines the temperature that needs to be reached during heating in order to get to the sterilization stage.	°F	212 °F- 284 °F	0.5°

Sterilization Temperature	Sterilization	Defines the temperature that needs to be maintained during sterilization.	°F	212 °F-284 °F	0.5°
Sterilization Time		Defines the length of time the sterilization temperature and pressure must be held.	Minutes	0-9999	0.5
Exhaust Mode	Exhaust	This parameter allows four choices; 1. Fast Exhaust 2. Fast Exhaust if the chamber pressure is less than atmospheric + 4.5psi, otherwise Slow Exhaust 3. Slow Exhaust 4. Slow Exhaust if the chamber has not completed sterilization, otherwise Fast Exhaust.	Whole Number	1-4	1
Dry Time	Drying	Defines the total length of the drying cycle.	Minutes	0-99	1
Dry heat On 1		Defines the ON time portion of the duty cycle for the heating elements during the first stage of the drying cycle.	Seconds	0-120	1
Dry Heat Off 1		Defines the OFF time portion of the duty cycle for the heating elements during the first stage of the drying cycle.	Seconds	0-120	1

Dry First Stage Time		The total drying cycle can be divided into two stages. This parameter defines the length of the first stage. The second stage will start at the end of the first and last until the end of the total drying cycle.	Minutes	0-120	1
Dry Heat On 2		Defines the ON time portion of the duty cycle for the heating elements during the second stage of the drying cycle.	Seconds	0-120	1
Dry Heat Off 2		Defines the OFF time portion of the duty cycle for the heating elements during the second stage of the drying cycle.	Seconds	0-120	1
Additional Dry Time		Defines the number of additional minutes to add to the default dry time	Minutes	0-60	1
End Temperature	Ending	Define the temperature at the end of the cycle that must be achieved before the cycle can end and the door be opened.	°F	86°F-302°F	1
Jacket Temperature	Global	This defines the chamber pre-heat temperature for the program selected. It is not recommended to go above 120°F. Too high a temperature will damage the autoclave. The pre-heat will maintain the chamber at this temperature between cycles and will begin immediately once the program is selected	°F	32- 302°F	1

6. PRINTER

6.1. *Printer Output*

The printing is on thermal paper with 24 characters per line and contains the following information:

- Date:
- Time:
- Ser. Num:
- Model:
- Software Version:
- Cycle Num:
- Cycle Name:
- Ster Temp:
- Ster Time:
- Dry Time:
- End Temperature:

When the sterilization cycle begins the printer starts printing the above data.

After the preliminary printing, the autoclave starts performing the sequence of operations of the cycle. The measured values of temperature and pressure are printed at fixed time intervals, according to the phase of the process, as shown in the table on the next page.

The data is printed from the bottom up, beginning with the date and ending with "Cycle Ended". For an aborted cycle, "Cycle Failed" and the Error message are printed (refer to "Displayed Error Messages/Symbols").

For an example of a typical printout, see the next pages.

Printer output

Description

Operator: _____ To be filled manually by the operator
Time: 12:14:47 **Time sterilization cycle ended**
Status: Cycle Ended

Stage and Time	Temp. (°F)	Pressure (psig)	Description
00:24:43	213.3	0.4	Cycle finished time
D 00:24:43	213.3	0.4	The time, temperature and pressure during drying
D 00:23:43	224.0	3.9	The time, temperature and pressure

E 00:23:43	224.0	3.9	during drying
E 00:22:08	273.5	29.8	The time, temperature and pressure during exhaust
CLK 2	00:22:08		Ending of the timer verification of the sterilization phase. The difference in clocks cannot exceed 3 seconds.
CLK 1	00:22:08		
S 00:22:06	273.5	29.86	The time, temperature and pressure during sterilization
S 00:21:06	273.6	29.9	
S 00:20:06	273.5	29.8	The time, temperature and pressure during sterilization
S 00:19:06	273.8	30.1	The time, temperature and pressure during sterilization
S 00:18:06	273.5	29.8	The time, temperature and pressure during sterilization
CLK 2	00:18:06		Beginning of the timer verification of the sterilization phase.
CLK 1	00:18:06		
H 00:16:35	262.9	22.5	The time, temperature and pressure during heating
H 00:13:35	240.3	10.4	The time, temperature and pressure during heating
A 00:00:45	129.3	4.44 InHg	
A 00:00:04	114.5	2.95 InHg	The time, temperature and pressure during vacuum stage
			The time, temperature and pressure during vacuum stage
TIME	°F	psig	

End Temperature:	248°F	Temperature when the cycle will end
Dry Time:	1 min	Dry time for the selected program
Ster. Time:	4.0 min	Sterilization time for the selected program
Ster. Temp:	273.2°F	Sterilization temperature for the selected program
Unwrapped Instruments		Cycle name
Cycle Num:	000001	Cycle number
Software vers:	2.0.3.97	Software version
Version:	0	
Model:	Elara11	Model name
Ser. Num:	000000000001	Model Serial number
Time:	08:33:29	Time of starting cycle
Date:	9/FEB/2010	Date of starting cycle

I/O Card vers:	7.3	
Software vers:	2.0.3.97	
Time:	08:33:29	Time of turning on
Date:	9/FEB/2010	Date of turning on
POWER ON		The device is turned on
Time:	00:00:00	Time of turning off
Date:	9/FEB/2010	Date of turning off
POWER OFF		The device is turned off

Legend

A Vacuum stage (Pulse L & Pulse H)
D Drying stage
H Heating stage
S Sterilization stage
CLK 1 Real Time Clock (see the explanation below)
CLK 2 Software clock (see the explanation below)
E Exhaust stage

CLK1 and CLK2

The autoclave has two clocks on its main board: real-time clock and processor clock. When sterilization starts, the system takes the readings of both clocks and compares them (see the printout). At the end of the sterilization stage, the discrepancy must not exceed 3 seconds.

6.2. Printer Handling

6.2.1. Maintenance

Wipe off any soiling on the printer surface with a soft cloth and a weak neutral detergent. After that, wipe the printer with a dry cloth.

6.2.2. Installing printer paper

Printer model PLUS II front view (see Fig. 1)

- 1-Paper mouth
- 2-Power On Led
- 3-Open Button (for opening the paper roll compartment)
- 4-Paper Feed key
- 5-Paper roll compartment
- 6-Paper end of roll sensor

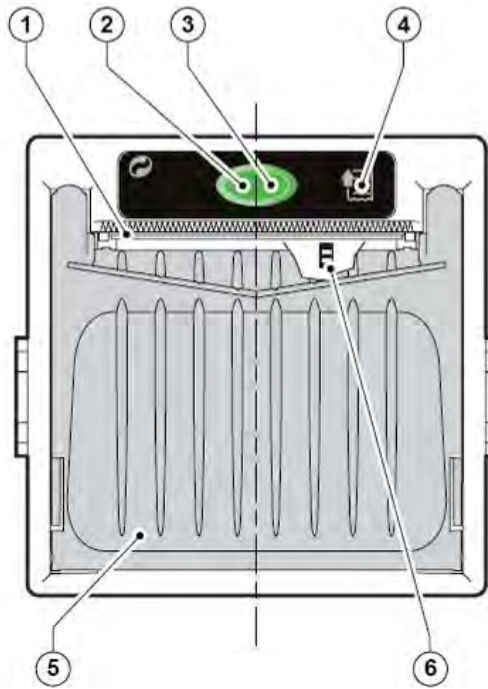

Fig. 1

1. Open the printer's cover door (3) by pulling it at the left bottom corner (2) (see Fig. 2).

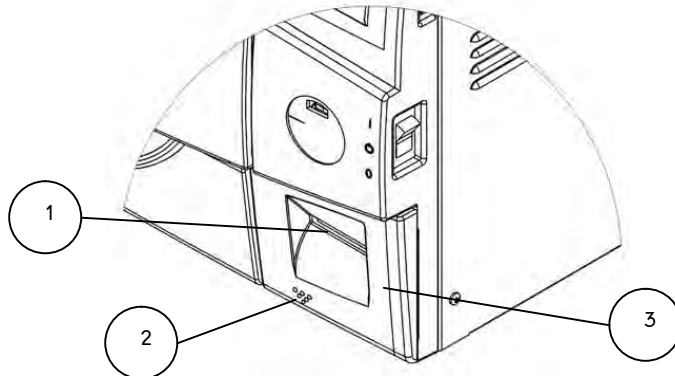

Fig. 2

2. Press the OPEN button to open the printer cover as shown (see Fig. 3/1). Handle the paper cutter carefully so as not to cut your hand.

3. Place the paper roll making sure it unrolls in the proper direction as shown (see Fig. 3/2).
4. The paper should roll off the top of the roll.
5. Hold the loose end of the paper with one hand and re-close the cover with the other hand as shown (see Fig. 3/3) the printer cover is locked.
6. Tear off any excess paper using the jagged edge (see Fig. 3/4).

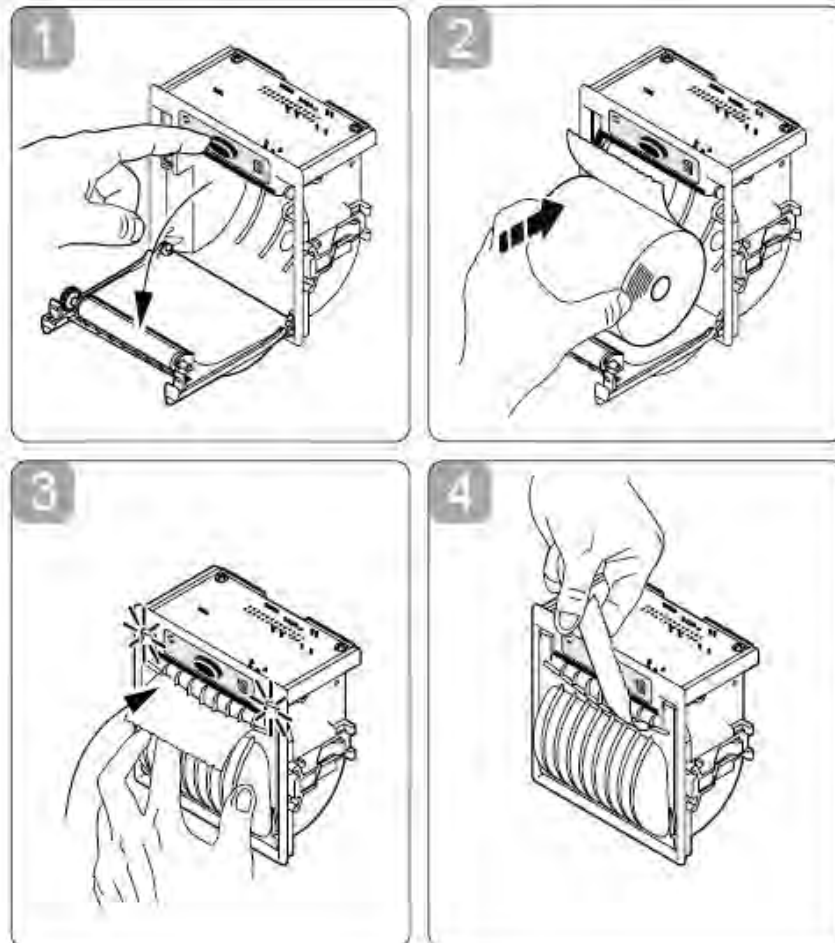

Fig. 3

7. Close the printer's cover door (3) by pressing corner (2), with the tip end of the paper emerging from the slot (1). See Fig. 2 on previous page.

6.2.3. Notes on treatment of thermal papers:

- Store the papers in a dry, cool and dark place.
- Do not rub the papers with hard substance.
- Keep the papers away from organic solvent.



CAUTIONS!

Never disassemble the printer. Failure to follow this instruction may cause overheating or burning of the printer or AC adapter or

an electric shock, which may lead to fire or personal injury. Use caution when cleaning the printer or autoclave. Splashing water, cleaning solution or other liquids into the printer can cause fire or electrical shock.

Never touch the thermal head immediately after printing as it becomes very hot. Make sure that the thermal head is cool before setting papers or cleaning the thermal head.

Power OFF the autoclave in any of the following cases:

The printer does not recover from an error.

Smoke, strange noise or smells erupt from the printer.

A piece of metal or any liquid touches the internal parts or slot of the printer.

7. INSTALLATION INSTRUCTION

7.1. *Lifting and Carrying*

Cautions!

Any time the autoclave is to be moved, Make sure that the electric cord is disconnected from the power, and there is no pressure in the chamber or steam generator.



1. Disconnect the power supply cord.

2. Drain the water from both reservoirs (see sec 10.4)

Attention! The pressure of the generator does not decrease immediately when the equipment is turned off. Carefully, using a tool, pull on the ring of the safety valve located in the mineral free water reservoir to relieve the pressure. **USE CAUTION THE STEAM WILL BE HOT!**

Do not drop the device!

Note: Lifting straps have been provided with this unit. Lifting straps are for one time use and should be removed and discarded after initial set up.

7.2. *Unpacking the autoclave*

Unpack the autoclave and inspect for mechanical damage upon receipt. Observe packing method and retain packing materials until the unit has been inspected. Mechanical inspection involves checking for signs of physical damage such as: scratched panel surfaces, broken knobs, etc.

To avoid injuries, lifting and carrying should be done with at least two persons

7.3. *Placing*



CAUTION: The installation described in this section must be done only by an authorized technician.



CAUTION!

The sterilizer must be placed on a rigid and leveled surface. The counter top or stand must be able to withstand the load of the device and loaded material. See sec. 1.11 for unit specifications.

Note: This unit requires a minimum counter depth of 24”

1. Check and verify that the counter carrying the autoclave is a rigid and leveled surface and can carry a load of **275lbs (125kg)**.



Attention: The ELARA11 is not designed for use on any standard slide out shelf. If it is necessary to use a slide out shelf, it must be tested and/or rated for 275lbs (125kg) or more.

2. The back of the autoclave **MUST** be a minimum of 2” from the rear wall. If placed in a cabinet, the rear of the cabinet **MUST** be open to allow ventilation. Failure to provide proper space for air circulation will result in failed cycles.
3. Check and verify that the counter dimensions are, at least, **22” x 24”**.

Note: Make sure while placing the autoclave, to leave space around the machine for ventilation and to give the technician access to service the machine. It is recommended that a minimum 2” (50mm) space be provided. Insufficient space for ventilation can cause cycles to fail and may result in an increase of the autoclave’s temperature which can damage the unit.

4. Check and verify that the room ventilation is 10 cycles per hour minimum.
5. Check and verify that the ambient temperature range is 41°F-104°F (5°C-40°C), it is preferable not to exceed 86°F (30°C).
6. Check and verify that the ambient relative humidity does not exceed 85%
7. Operate the autoclave only in the manner specified in the manual. If the equipment is used in a manner not specified by the manufacturer, the protection provided by the equipment may be impaired.

7.4. Electrical

Check and verify that the power supply is a 1 or 2 phase, 230Vac ±5%, 60Hz, 15A supply

The electrical connection should comply with the devices power requirement. It must also comply with local installation and safety rules and regulations. The voltage supplied to the device must comply with

the device label $\pm 5\%$. If needed a 0.5 KVA Buck/Boost transformer can be installed to adjust the voltage.

Note: It is recommended that the device be on a dedicated electrical circuit.

Note: The autoclave **must** be connected to a properly grounded outlet.

In order to avoid any personal injury due to electrical shock, it is mandatory to have installed an earth leakage relay (GFCI outlet or circuit breaker) in the electrical circuit to which the autoclave is connected. This relay disconnects all electrical power in case of accidental contact with any electrically energized parts of the autoclave,

7.5. Setup

Your new Tuttnauer Autoclave was programmed and tested at the factory and requires a minimum of setup.

1. Make sure the counter is level and sturdy (see sec. 7.3 above).
2. Make sure all the feet are on the autoclave and none of them has been lost.
3. Position the autoclave on the counter (see sec. 7.3 above).
4. Connect the power cord to the socket on the rear side of the autoclave; then plug it into the supply outlet.
5. Turn on the power switch located on the right side of the unit.
6. Set Date and Time will appear on the screen. On initial set up it is important to set the date and time see sec. 5.1.6 Setting the date and time will cause the software to reload.
6. This machine is equipped with an electronic door lock. The door will **NOT** open when the power is off or the system is running a cycle or an error message is displayed.
7. When the software has finished loading the door will unlock. To prevent melting of the plastic packing material in the chamber, open the door and immediately use the arrow keys on the EZPad to advance to the Vacuum Test Cycle. This will turn off the pre heating mode. Make sure to remove all accessories and plastic material from the chamber.
8. Fill the reservoir (see sec.7.6) with steam distilled water (see sec. 1.18 for water quality specifications)

The unit is now ready to run sterilization cycles.

Note: At the time of installation and anytime the unit is turned on the atmospheric pressure parameter will automatically reset. The atmospheric pressure parameter can be manually reset at any time (See sec. 5.2.3.1).

7.6. *Filling the Mineral-Free Water Reservoir.*

Use only steam distilled water having the characteristics described in sec. 1.18

1. Open the door (1). The autoclave needs to be on for the door to open.
2. Pour steam distilled water, gently, into the front funnel (2) until it reaches the top of the blue area (3) on the level gauge. If water is filled above the blue area into the red area (4) then use the drain hose to drain off the over fill (see sec. 10.4). It is preferable to use a carafe or small pitcher when filling.

Note: This reservoir is designed with an over flow and filling the reservoir above the safe level as indicated on the Front Fill Funnel will cause excess water to spill out below the machine onto the counter.



CAUTION!

Under no circumstance should water be filled higher than the blue area (3) on the level gauge.

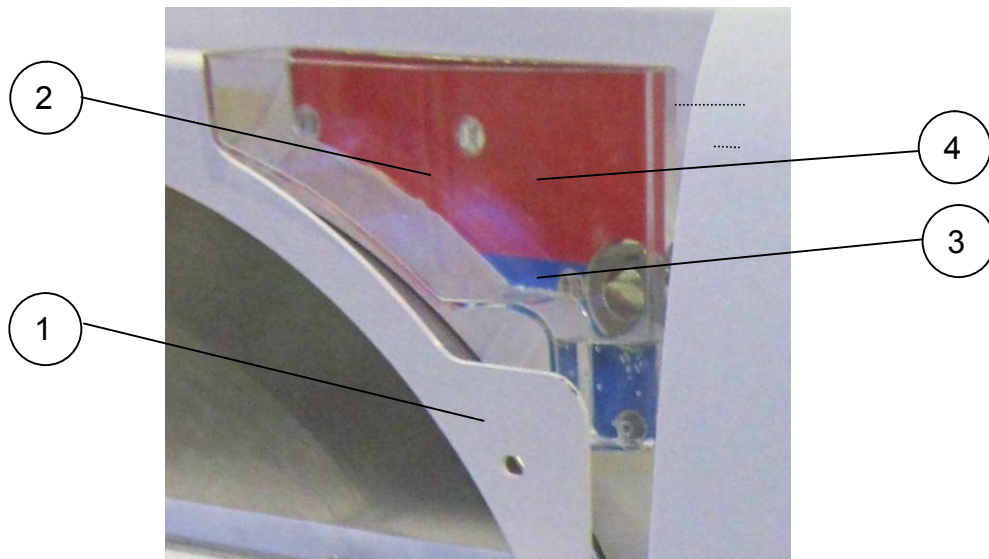

- If the reservoir is empty, it can be filled quickly by adding water directly through the opening at the top of the reservoir, as follows:
4. Remove the water reservoir cover (6).
 5. Pour steam distilled water into the reservoir through the opening on top of the autoclave until it reaches the base of the safety valve holder (7) or reaches the top of the blue area of the level gauge.



CAUTION!

Under no circumstance should water be filled above the safety valve holder.

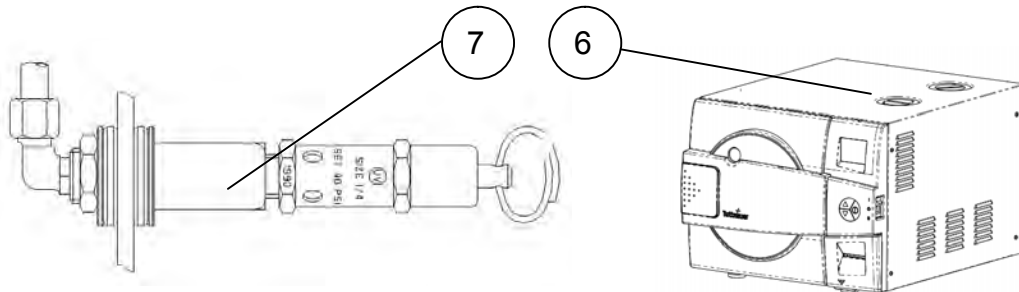

In case more water is accidentally filled above the blue area or safety valve, decrease the water level by draining the reservoir before starting a cycle (see sec. 10.4).

Note: This reservoir is designed with an over flow and filling the reservoir above the safe level as indicated on the Front Fill Funnel will cause excess water to spill out below the machine onto the counter.



CAUTION!

USE STEAM DISTILLED WATER ONLY having the characteristics as per table in sec. 1.18. The impurities in water from a well, spring or municipal water supply will create the need for more frequent cleaning and maintenance

This type of water can damage your instruments, your unit and void your warranty.

Caution!



Waste water should be brought into the public net in accordance with the local rules or requirements
ONLY NON-HAZARDOUS LIQUIDS SHALL BE DISPOSED IN PUBLIC SEWAGE!

8. PREPARATION BEFORE STERILIZATION

The purpose of packaging and wrapping of items for sterilization is to provide an effective barrier against contamination once the items have been sterilized and removed from the sterilizer.

Packaging and wrapping materials should permit the removal of air from the pack during heating, penetration of the steam vapor into the pack during sterilization and removal of the steam vapor during drying.

The basic principle determining the size, mass and contents of instrument pouches, cassettes and hollowware packs is that the contents are sterile and dry immediately on completion of the drying cycle and removal from the sterilizer.

Instruments to be sterilized must be free from any residual matter, such as debris, blood or organic tissue. Instruments must also be dry and free from mineral deposits. Such substances may cause damage to the instruments themselves or the sterilizer.

Correct loading of the autoclave is essential for successful sterilization. Efficient air removal from the chamber and load will permit total steam penetration and saturation. Additionally, correct loading will promote efficient drying and reduce damage to packs and their contents and maximize the effectiveness of the sterilizer.

Notes: In order to protect sensors at the back bottom of the chamber, the rack of the Elara11 is designed with stops for the bottom tray. It is normal for the bottom tray to be closer to the door than the other trays.

Pushing the bottom tray all the way back will cause it to interfere with the chamber sensors.

1. Check the instructions of the item manufacturer as to the proper procedure for cleaning and sterilizing each item. The item manufacturer's instructions always supersede any other instructions.
2. Clean instruments immediately after use to remove any residue. It is recommended that all instruments be ultrasonically cleaned using **Tuttnauer™ Clean & Simple** enzymatic cleaning tablets or other suitable solution.
3. After cleaning, rinse instruments under tap water for 30 seconds and pat dry to remove residual minerals. If your tap water has a high mineral content, then rinse a second time in a bath of distilled water to remove minerals and pat dry.
4. Launder textile wraps prior to sterilization, thoroughly rinse wraps laundered in chlorine bleach. Chlorine bleach can harm your stainless steel instruments and the sterilizer.
5. Follow the instrument manufacturer's instructions on the use of products for cleaning and lubricating instrument that have been ultrasonically cleaned.
6. Be sure that instruments of dissimilar metal (stainless steel, carbon steel, etc.) are separated. Carbon steel instruments should be bagged

or placed on autoclavable towels and not directly on stainless steel trays (mixing will result in damage to the instruments or trays from the electrolysis of these materials).

7. Load items within the boundaries of the tray so that they do not touch the chamber walls, or fall off when the tray is moved. Items should not be allowed to touch the walls of the Chamber as the hot metal can damage the item.
8. Don't overload the Sterilizer trays. Overloading will inhibit sterilization and produce poor drying results.
9. Items must be sterilized in an open position. Surfaces that are hidden because the item is in a closed position will not be exposed to the steam and will not be sterilized.

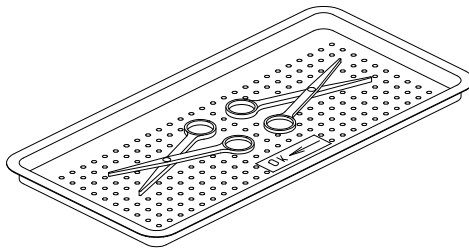

10. Make sure that all instruments remain apart during the sterilization cycle. Surfaces that are hidden because items are covering other items will not be exposed to the steam and will not be sterilized.
11. Disassemble or sufficiently loosen multiple-part instruments prior to packaging to permit the sterilizing agent to come into contact with all parts of the instrument.
12. Verify that packaging methods are in accordance with the good practice approach and the packaging materials used are in agreement with applicable standards.
13. Tilt on edge items prone to entrap air and moisture, e.g. hollowware, so that only minimal resistance to removal of air, the passage of steam and condensate will be met.
14. Allow a distance of approximately 1" (2.5 cm) between trays to permit steam circulation.
15. Wrapped instruments should be placed in material which will allow steam penetration and promote drying, such as autoclave bag, autoclave paper, or muslin towels.
16. When using a paper / plastic bag, the plastic side should always be up.
17. Do not stack pouches. It is recommended that a pouch rack such as the **Tuttnauer™ Pouch Rack** be used to ensure proper steam penetration and adequate drying. Surfaces that are hidden because the items are being stacked will not be exposed to the steam and will not be sterilized.

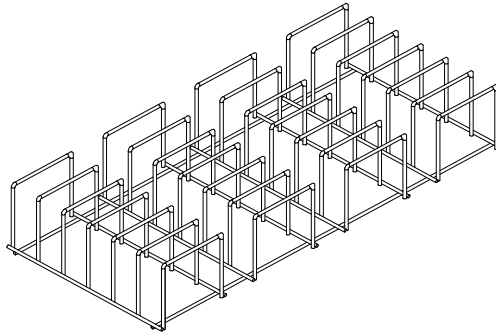

18. Empty canisters should be placed upside-down, in order to prevent accumulation of water (see the figure below).
19. When sterilizing glassware use only heat-proof glass. Glassware needs to be placed on the tray with the open end down.



20. Tubing should be rinsed after cleaning. When placed in the tray, make sure that both ends of the tubing are open and there are no sharp bends or twists.

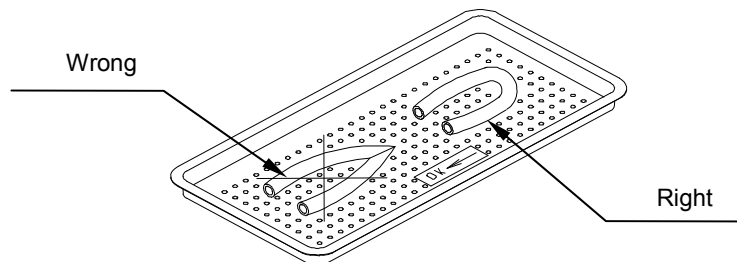

21. Cassettes or packs should be placed on the tray rack in place of the trays. They should not be touching each other or the Chamber walls. There should be about $\frac{1}{2}$ " (1.25cm) between cassettes or packs for proper steam circulation.
22. Cassettes in an ELARA11 should be sterilized in a vertical position (see the figure below). To adjust the rack for vertical sterilization of cassettes remove the trays and gently squeeze the sides of the rack inward and at the same time rotate the rack into a vertical position.



23. Small packs can be placed directly on the tray in an upright position. They should not be touching each other or the Chamber walls. There should be about ½" to 1" between packs for proper steam circulation.

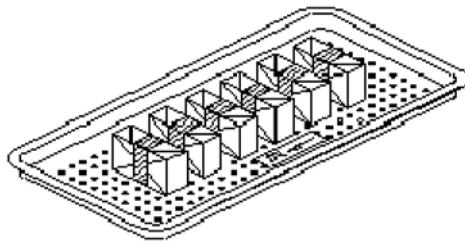

24. Place a sterilization indicator on each tray and/or inside each wrapped cassette.
25. At least once a week use a biological spore test (*Bacillus Stearothermophilus*) in any load to insure proper sterilization (be aware testing standards may vary). Always follow the spore test manufacturer's instruction.
26. If spotting is detected on the instruments it is necessary to determine if the spot is dirt or oxidation. The first step would be to use an ordinary eraser to remove the spot. If there is no pitting under the spot then the spot is only dirt. Dirt spots on an instrument may be an indication that the autoclave needs to be cleaned or that the instruments were not adequately cleaned prior to sterilization. If removal of the spot reveals pitting, then the spot is most likely oxidation. oxidation spots on an instrument are not uncommon on inexpensive instruments. It may also be an indication that the instruments were rinsed in tap water with a high mineral content. These minerals when exposed to high temperature and steam will accelerate the oxidation of the metal. One suggestion would be to final rinse the instruments in a distilled water bath and pat dry to absorb residual water and minerals.
27. If the instruments exhibit a discoloration this can be due to the mixing of carbon steel and stainless steel. When these two metals come into contact with each other electrolysis occurs that breaks down the metal. The best solution is to separately wrap the carbon steel instrument to insulate it from other instruments on the tray and from the tray itself.
28. **This unit is not approved for sterilizing liquids of any type.**

9. OPERATING INSTRUCTIONS

It is recommended to perform B&D test cycle (see 4.8) at the beginning of each working day.

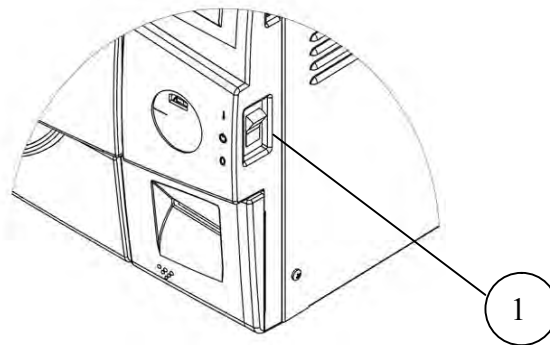

Turning on the autoclave

1. Plug the power cord into the back of the autoclave and into the wall outlet.
2. Turn on the rocker switch mounted on the side of the front panel.

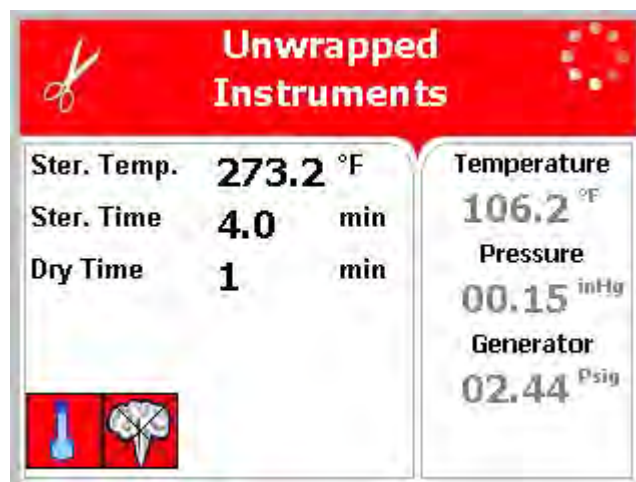

9.1. Pre-Heating



When the unit is turned on the pre-heating begins. The steam generator begins heating and the symbol  is displayed until the generator is ready. The chamber is also pre-heated and the symbol  is displayed until that process is completed. Pre-heating continues with the door opened or closed.

Sterilization cycles cannot be started until the preheating is completed.

Note: If the unit is in the Vacuum Test mode the heaters are turned off. When the pre-heating is complete the pre-heat symbols will be removed from the EZView display.

9.2. Waste Water Reservoir

The Elara11 has two reservoirs, a mineral free reservoir for clean steam distilled water and a waste water reservoir for water that has gone through the sterilization process. When the waste water reservoir is full, the symbol  is displayed. This situation is normal; however the operator cannot run a new cycle before draining the waste water reservoir (see 10.4). The Elara11 comes with an optional rear drain that can be connected to a building drain. If the rear drain is connected, the waste water reservoir will always be empty.

NOTE: The temperature of the waste water can be over 200°F (93°C). Plastic drain pipe cannot tolerate temperatures above 140°F (60°C). An external heat exchanger may be required to cool the discharge.

9.3. Opening the Door

This machine is equipped with an electronic door lock. The door will not open when the sterilizer is running a cycle or the power is off or an error message is displayed.

Open the door by following these steps:

1. Place your thumb on the plastic door cover (1) and the other fingers in the handle (3).
2. Pull the handle (2) until the latch of the door is released.
3. Open the door.

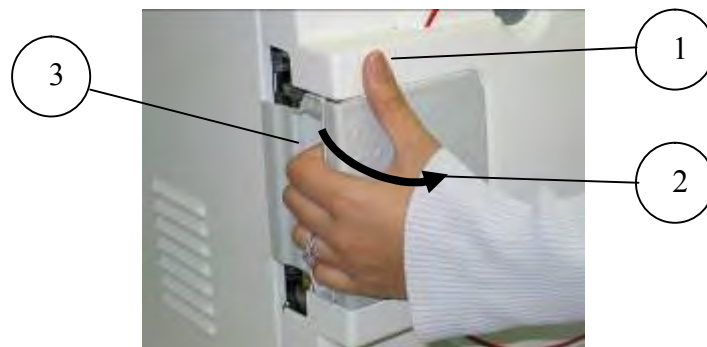

4. With the door open you can now fill the reservoir as per the instructions in section (see 7.6).

Note: The first time you start the unit it is important to set the date and time (see sec. 5.1.6)

9.4. Adding additional drying time

If the default drying time is not adequate for the load to be sterilized, additional drying time can be added. See sec. 5.1.1 for detailed instructions on adding extra drying time.

Tuttnauer strongly suggests that each user/operator learn how to arrange the load and apply additional drying time. This will ensure that your sterilizer provides efficient drying of the pouched and/or wrapped instruments used in your office

Tuttnauer affords you the ability to adjust drying times to accommodate various instrument loads. Since no two instrument loads are the same it is important to match the drying time with the load. In addition, proper packaging is important. Like materials should be packaged together. Carbon steel should not be mixed with stainless instruments. Plastic instruments should be separated from metal instruments. Pouched items should be separated on the tray and should only be one layer deep. When using paper/poly bags the paper side should be down. Using a **Tuttnauer™ Pouch Rack** will insure good air circulation and more efficient drying.

9.5. Loading

1. Load the autoclave properly according to instructions in sec. 8.

Be sure that instruments of dissimilar metal (stainless steel, carbon steel, etc.) are separated (see sec. 8 #6).

Observe maximum weight limits as referenced in the table in sec. 1.11

When sterilizing wrapped instruments it is recommended that a pouch rack such as the **Tuttnauer™ Pouch Rack** be used to ensure proper steam penetration and adequate drying when sterilizing pouched instruments.

If a pouch rack is not available then the pouches need to be laid out plastic side UP and only one layer deep on each tray.

Note: Pushing the bottom tray all the way back will cause it to interfere with the chamber sensors.

When sterilizing cassettes in the Elara11 it is recommended that they be loaded vertically (see picture below). To adjust the rack for vertical sterilization of cassettes, remove the trays and gently squeeze the sides of the rack inward and at the same time rotate the rack into a vertical position.



Loading of heavy and diverse loads

When sterilizing heavy loads we recommend using a **Tuttnauer™ Pouch Rack**. See the figures below showing examples of using a combination of trays and racks for sterilizing heavy or diverse loads.

The Elara11 is supplied with 5 wire trays.

NOTE: The Elara11 can accommodate 2 pouch racks.

Elara11



1. Ensure that the correct sterilization program is selected:

- Use the **UP** or **DOWN** keys to select the program to run.

- The program can only be changed when the door is open.

2. If needed additional drying time can be added at this time (see Sec. 5.1.1).

Note: Pushing the bottom tray all the way back will cause it to interfere with the chamber sensors.

3. Close the door by either:

- Holding the handle in the open position while pushing the door until it comes to the closed position, then releasing the handle.
- Pushing on the door handle and gently pushing the door closed.
- When the door is properly closed and the mineral free reservoir is full and the pre-heating is complete, the open door symbol  is then replaced by the message "System Ready".

5. Start the cycle by pressing the **START/STOP** key.

- The door is now locked.
- Stopping the cycle now will generate a cycle fail message.

9.6. Cycle Description

The autoclave starts performing the sequence of operations.

The actual measured values of pressure and temperature are displayed continuously and printed on the printer. The EZView display shows the current stage of the cycle. (See sec. 3.1).

In any program that has a drying stage scheduled, the dry stage begins after the steam exhaust stage. The autoclave is equipped with a vacuum pump that during the drying stage creates a vacuum in the chamber drawing moisture from the instruments. Drying is performed with the door closed.

At the end of a successful cycle, the screen shows the Cycle Ended message and the door is automatically unlocked. The air valve is opened to prevent formation of a vacuum.

In the event of a program failure, the exhaust valve is opened to release pressure from the chamber and a fail message is displayed.

There is a mandatory 1 minute of drying before the door can be opened. When the mandatory drying is completed pressing the **START/STOP** key will clear the error message and unlock the door.

9.7. **Extra Drying Time**

If you see that additional drying is needed, with the door open use the Up / Down keys to select Extra Drying Time, then close the door and press the Start/Stop button to run the Extra Drying Time cycle (see sec.4.6). The default additional drying time is 5 minutes, however it can be altered by the user (see sec. 5.1.1).

9.8. **Unloading**

When the cycle has ended successfully, the message "Cycle Ended" is displayed and the door is automatically unlocked.

The door can be opened and the load removed.



WARNING!

To avoid severe injuries from hot steam when opening the door:

It is strictly forbidden to lean on the autoclave.

It is strictly forbidden to place your hand or any part of your body over the door.

Use the tray handle or wear heat-resistant gloves to remove the load from the autoclave.

On completion of the cycle, the load shall be visually inspected to ascertain that the load is dry, and that sterilization indicators have made the required color change.



Warning!

The sterility of the instruments processed in unwrapped cycles cannot be maintained if exposed to non-sterile environment.

Stopping the process manually

It is possible to stop the program while the autoclave is operating. Pressing the **START/STOP** key at any stage of the process stops the operation. Any cycle that stops prematurely is considered a failed cycle.



WARNING! If the cycle was aborted before completing the sterilization stage, it will leave the load unsterilized. Handle it as a contaminated load.

If the cycle is manually aborted **before** completing the sterilization stage, the screen becomes yellow; a caution symbol is displayed with the message "Cycle Failed" and an error message stating the reason for the

failure. (See sec. 3.3).

If the cycle is manually aborted **after** the sterilization stage is completed, the screen will remain white with the message "Cycle Ended" and a second message stating the reason for the failure. (See sec. 3.2.)

There is a mandatory 1 minute of drying before the door can be opened.

When the mandatory drying is completed pressing the **START/STOP** key cancels the displayed error message and unlocks the door so it can be opened.

Stopping the process due to cycle failure

The cycle can stop itself if the unit detects a problem.



WARNING! If the cycle was aborted before completing the sterilization stage, it will leave the load unsterilized. Handle it as a contaminated load.

If the cycle is aborted **before** completing the sterilization stage, the screen becomes yellow; a caution symbol is displayed with, the message "Cycle Failed", and an error message stating the reason for the failure. (See sec. 3.3)

If the cycle is aborted **after** the sterilization stage is completed, the screen will remain white with the message "Cycle Ended" and a second message stating the reason for the failure. (See sec. 3.2.).

There is a mandatory 1 minute of drying before the door can be opened.

When the mandatory drying is completed pressing the **START/STOP** key cancels the displayed error message and unlocks the door so it can be opened.

10. PREVENTIVE AND SCHEDULED MAINTENANCE

The maintenance operations described in this chapter need to be followed as indicated to keep the device in good working condition. This maintenance schedule is the responsibility of the equipment owner and not covered under the warranty.

The majority of instructions that follow can easily be carried out by the operating personnel and do not require a service technician.

Should the need arise or the instructions in this section indicate, technical assistance or a service technician can be requested by either calling your dealer or Tuttnauer USA.

10.1. *Daily by the Operator*

Turn the unit on momentarily to allow the door to be opened. Open the door, then turn the unit off to stop the chamber from pre-heating and proceed with cleaning.



Caution!

Make sure the autoclave is not hot before cleaning it.

- Clean the door, door gasket and outside rim of the chamber with a mild detergent, water and a soft cloth or sponge. The gasket should be clean and smooth. Be sure to clean the inside and outside of the gasket flap.
- Remove the tray holder and trays. Clean the interior of the chamber with a damp cloth or sponge. Wiping out the chamber each morning will keep the chamber clean.



- Clean the tray holder and trays with a non-abrasive stainless steel cleaner and water, using a soft cloth or sponge. Rinse the tray holder and trays immediately after cleaning with clean water to avoid staining the metal. Wipe dry with a soft cloth or paper towel.



CAUTION!

Do not use steel wool, steel brushes, bleach or any cleaning agent containing bleach or anything abrasive to clean the chamber, tray holder or trays. Doing so will damage the chamber and trays!

10.2. *Weekly by the Operator*

- Clean the outer parts of the autoclave with a soft cloth.
- Replace mineral free water in the reservoir.
- If the autoclave is only used occasionally, drain the water from the mineral free water reservoir once a week, and refill with fresh distilled water (see 7.6).
- Once a week or when symbol  is displayed (whichever comes first) drain the water from the waste water reservoir (see 10.4). Put 1-2 drops of oil, such as 3 IN ONE Oil, on the door pins and any moving parts of the door locking mechanism (See the figure below).

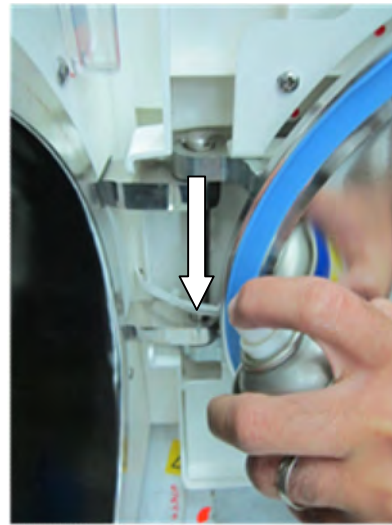
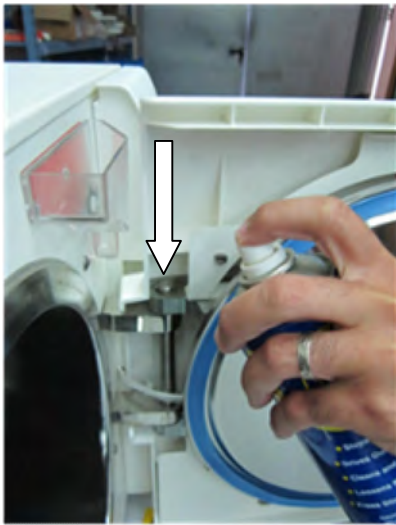

10.3. Periodically By the Operator



Caution!

Make sure the autoclave is not hot before cleaning it

1. Once a month, check both safety valves.
2. Once a month clean the strainer as per para. 11.6. Cleaning frequency may be reduced according to experience.
3. Replace the air filter, every 6 months or after 1000 cycles (whichever comes first) according to 12.3.
4. Every 3 months check the door gasket for any signs of physical damage replace it if there is a tear or leakage.

10.4. Draining the Reservoir

(Applies to the clean-water reservoir and to the waste-water reservoir)

The drain valve is located on the front right side of the autoclave after the door is opened (1). The function of the drain valve is to drain the water reservoir.

1. To drain the reservoir, use item (5) with the plastic hose (6) attached to it (supplied with the autoclave).
2. Insert part (5) into valve (3) and press it until you hear a click. The drain valve opens immediately, drain into a bucket.
3. When the water reservoir is empty, press part (4). Item (5) will pop out approx. 3mm and the drain valve will be closed. Remove item (5) with the plastic tube.
4. If the drained reservoir is the clean-water reservoir, fill reservoir with distilled water until it reaches the full level. (approximately 1.72gal (6.5 liters)).
5. Turn on the main power switch.
6. The autoclave is now ready for use.

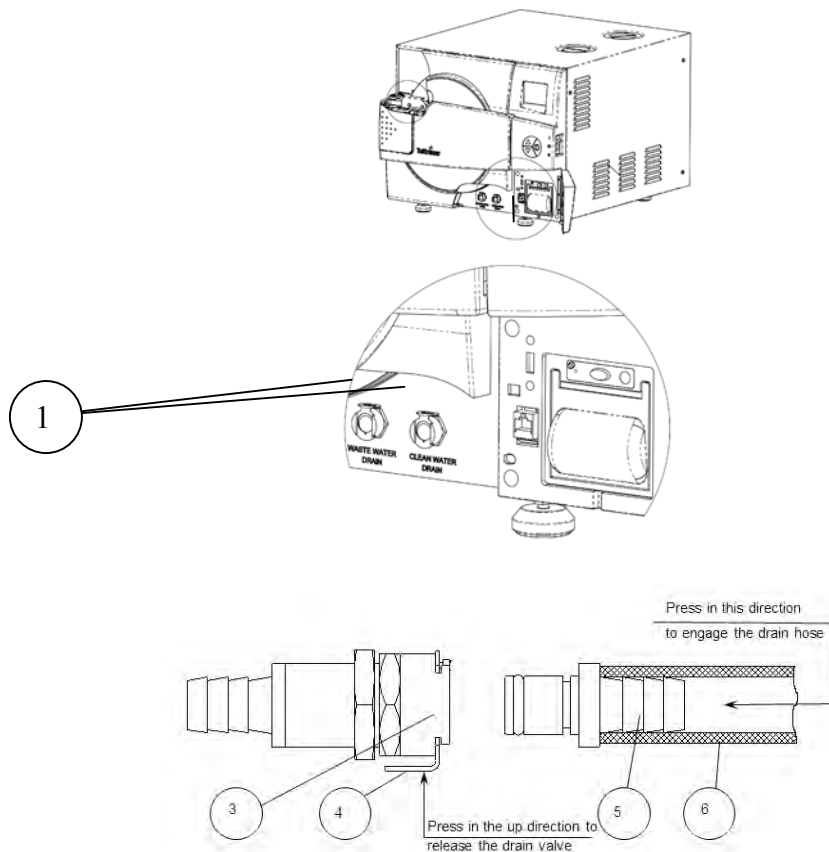

10.5. Replacing the Air Filter



Cautions!

Carefully un-pack the new filter, and examine it for any signs of damage.

Remove any protective packaging before inserting the filter into place.

In order to “break” the vacuum, at the end of the dry phase, filtered atmospheric air is allowed to enter the chamber via a solenoid valve. The filtration of the air is performed by the bacteriological (HEPA) filter. The filter is mounted on the rear wall of the autoclave enclosure, to allow easy access for replacing. (see Rear View, position 4).

To replace the filter, proceed as follows:

1. Remove the filter cover (2), by turning the cover counterclockwise until it is released.
2. Remove the filter (3) from the filter cover by unscrewing the filter from the filter cover.
4. Replace the filter with a new one. Connect the filter (3) to the flexible tubing (5) and tightening it with a tie wrap (4).
5. Connect the filter to the filter cover by screwing the filter (3) into the hole in the cover (1).

6. Insert the filter into the autoclave and secure the filter cover by turning it a $\frac{1}{4}$ turn clockwise. Verify that the tube has not been kinked and that the cover is fastened securely.

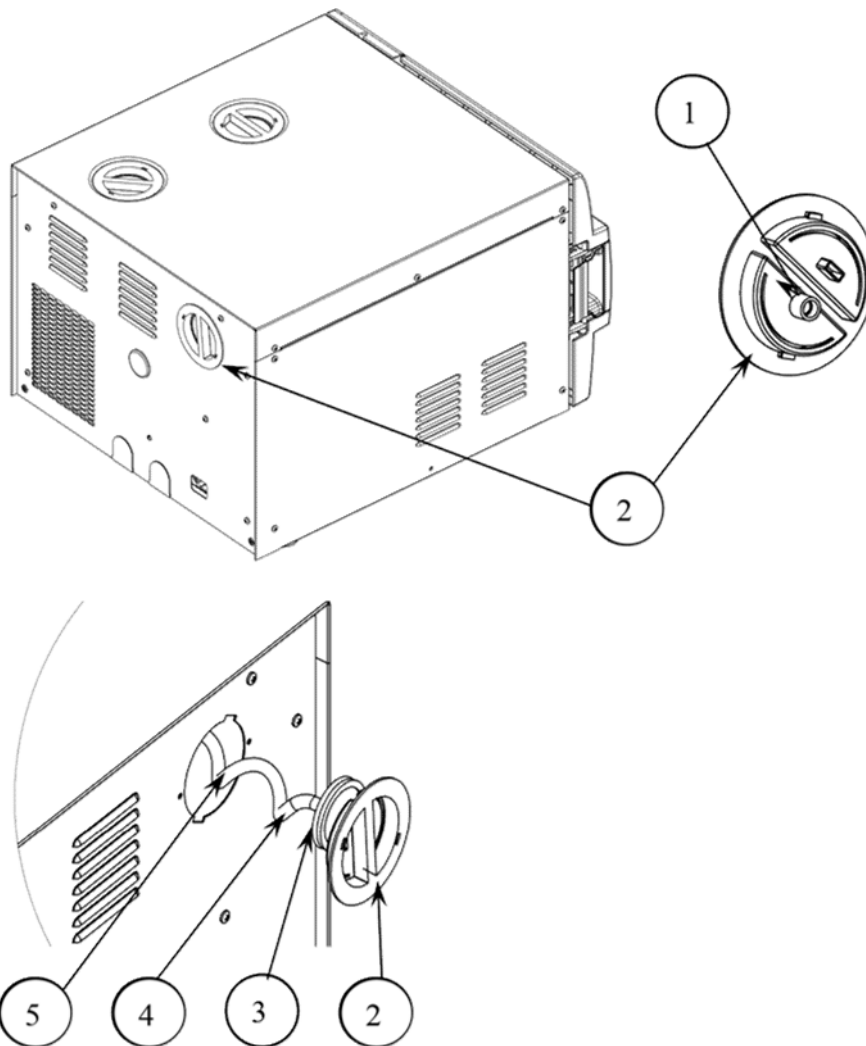
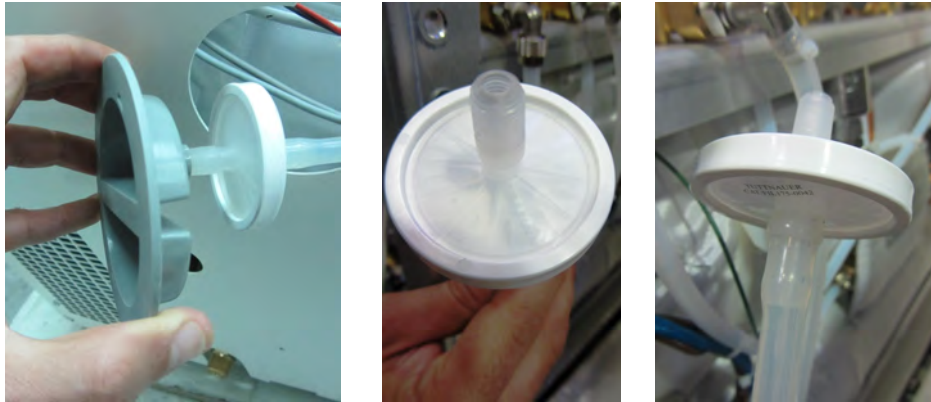

Note: It is recommended to replace the air filter, every 6 months or after 1000 cycles (whichever is the shorter period).

10.6. Replacing the Door Gasket



To avoid injuries, replace the gasket while the autoclave and autoclave door are cold.

Pull off the gasket from the door groove and install the new gasket referring to the directions below.

1. Pull off the gasket from the groove.

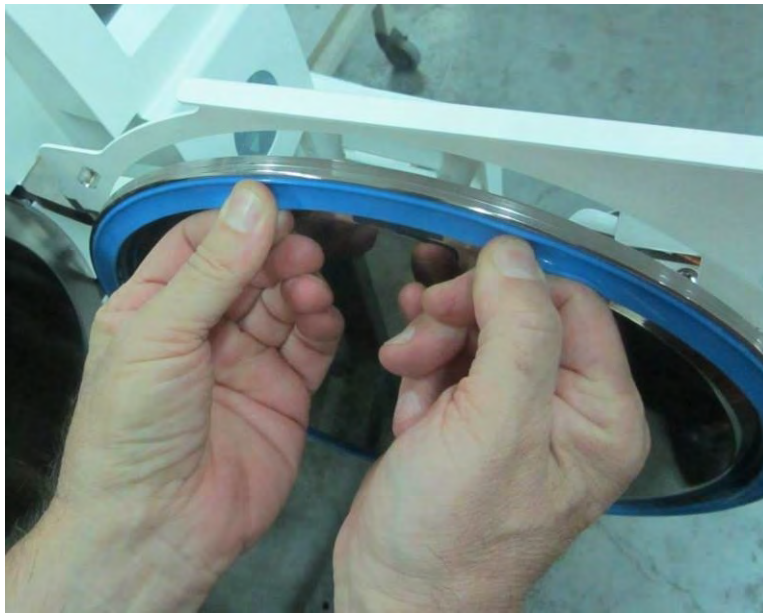

2. Clean the groove of any remnants of the old gasket (use a plastic scraper and plain water as needed).

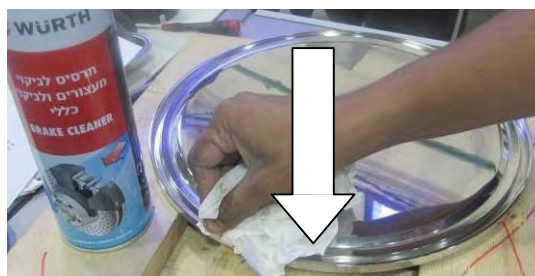

3. Line the inside of both sides/walls of the gasket groove with a small amount of silicon lubricant. This can be sprayed in or brushed in depending on the type lubricant you use. Make sure to fully coat the inside of the groove.



Note: It is necessary to use a silicone based lubricant such as Würth Silicone Lubricant or Dow Corning 111, when installing the door gasket.



CAUTION! If insufficient lubricant is applied - replacing the gasket will be difficult. If excess lubricant is applied, the gasket will 'spring' out of the groove.

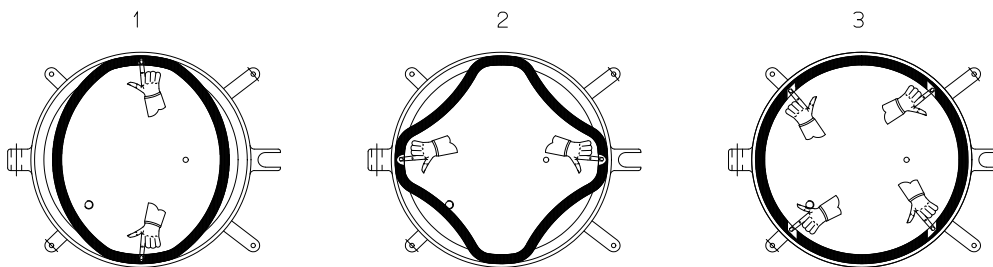

Place the gasket inside the groove and press it in with a finger following the pattern above.

Once the gasket is pressed in use your finger or a smooth plastic tool to smooth it all the way around the groove.



Caution!

Make sure the gasket sits evenly without waves, humps, or cavities.

If the door gasket is not perfectly smooth it will not seal the chamber properly

This drawing shows the correct direction of the gasket.



Gasket

Door

10.7. Checking the Safety Valve

There are two safety valves located in the mineral free water reservoir

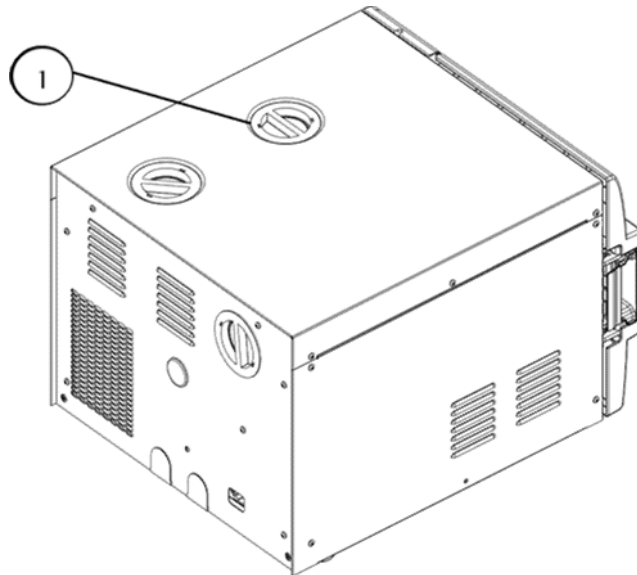

In order to prevent the safety valve from becoming blocked, it is necessary to open the valve under pressure. This will allow the steam to escape clearing the seat of the valve. Once per month, perform the following procedure:

1. Operate the sterilization cycle according to the manual, but with no instruments.
2. Allow a pressure of approximately 29 Psig (300KPA) to build up in the chamber.
3. Remove water reservoir cover (1).



CAUTION!

The next step will expose you to hot steam. To avoid being burned by hot steam, keep all body parts away from the steam flow.

1. Pull the ring of each safety valve in turn using a tool, i.e. screwdriver, hook etc., open the safety valve ring for 2 seconds, and then release it. Be careful not to burn your hands.
2. After 2-3 seconds the safety valve should close automatically.
3. Press the **START/STOP** key to abort the cycle, and allow the steam to exhaust from chamber.
4. Wait until the pressure goes down to zero, only then can the door be opened.
5. If the safety valve closes properly the procedure was successful.
6. If the safety valve does not close or leaks steam or water when it does close the safety valve needs to be replaced. This will require an authorized service technician.

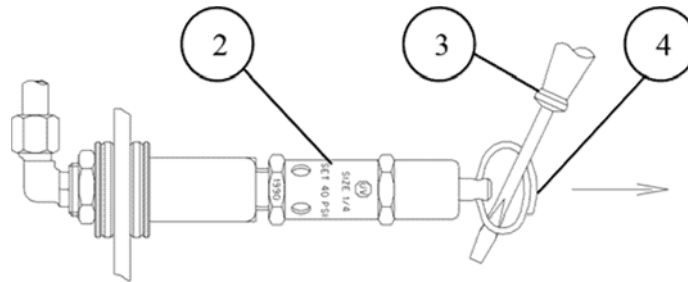

No.	Description
1	water reservoir cover
2	Safety valve
3	Pulling device
4	Pressure relief ring

10.8. *Cleaning water strainer*

CAUTION!



Do not touch the strainer or chamber shortly after operation as they will be very hot.

Touching the hot strainer may cause severe injuries. If this maintenance operation is performed while the strainer is hot, use heat resistant gloves to avoid injuries.

1. Turn the unit on momentarily to allow the door to be opened. Then turn the unit off to stop the chamber from preheating.
2. Remove the trays and the tray holder.
3. Remove the strainer element mounted on the bottom-rear of the chamber.
4. Clean the strainer with water using a nylon or brass bristle brush if necessary.
5. Reinstall the strainer element.
6. Reinstall the tray holder and the tray.

Strainer element



The strainer element is located on the back of the chamber



10.9. *Emergency opening of the door*



Caution! This option is for emergency cases only! Before opening the door, always make sure that there is no pressure in the chamber and the electric cord is disconnected (See above).

If there is no power to the autoclave and the door is closed the lock will be engaged. If you need to open the door, follow this procedure:

1. Turn the power switch off.
2. Wait at least one hour until the autoclave cools down.
3. Verify that there is no pressure in the autoclave chamber by pulling the ring of the chamber safety valve (see sec. 10.7).
4. Insert a 2 mm (0.08") pin (1) into the hole (2) located above the door opening handle (3).
5. Press the pin downwards and, simultaneously open the door by pulling the door handle (3) in the direction of the arrow (4).
6. When the door handle starts to open remove the pin and finish opening the handle.

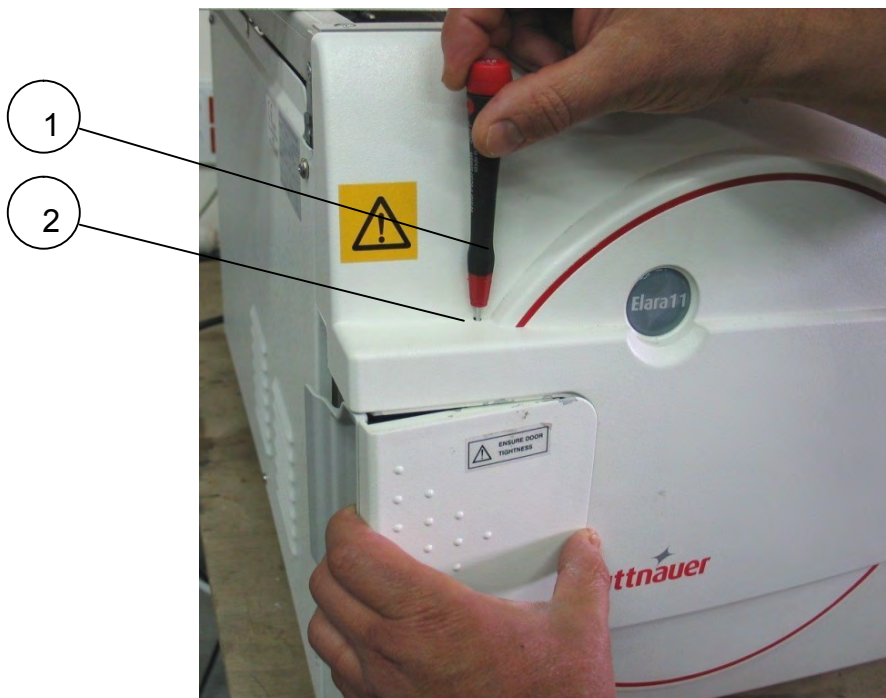

11. TROUBLESHOOTING



This troubleshooting chart enables the user to solve minor malfunctions, prior to requesting service. Only technical personnel having proper qualifications and holding technical documentation (including a technician manual) and adequate information are authorized to service the apparatus.



For technical assistance call your dealer or Tuttnauer USA

Problem/ Error Message	Message / Symbol Description	Corrective Action
Door will not open	Sleep mode is active and the screen saver is displayed	Awaken the unit from the sleep mode by pressing the START/STOP key.
	The power is turned off.	Turn power on
	The machine has not returned to normal pressure	Wait for the machine to return to normal pressure
	An error message is displayed	Press the START/STOP key to clear the error message and unlock the door.
Display is not activated	The on/ off switch is in the off position. The power cord is not connected properly to the machine and the power source. There is no electrical power in the main source.	Turn the on/ off switch on. Make sure the power cord is properly connected to the machine and the power source. Fix the electrical power supply.
The printer does not print	The paper is not inserted correctly in the printer.	Make sure the paper is inserted in the printer correctly (see 6.2). Switch the machine off then back on. If the printer prints the date and time, the printer is O.K.
"Analog Input Error"	This message is displayed when any Temperature sensor or Pressure sensor is disconnected or out of range.	Turn the unit off and then back on. If the message reappears Call for service
"Chamber temperature not in range"	This message is displayed if the temperature in the chamber is higher or lower than the normal range.	Wait until the chamber reaches the normal temperature range. If this takes more than 5 minutes call for service

Problem/ Error Message	Message / Symbol Description	Corrective Action
"Chamber pressure not in range"	This message is displayed if the pressure in the chamber is higher or lower than the normal range.	Wait until the chamber reaches the normal pressure range. The atmospheric pressure parameter may need to be set. See section 5.2.3.1
"I/O Card Failed"	This message is displayed if I/O card is faulty (both while cycle is running or not).	Turn the unit off and then back on. If the message reappears Call for service
"I/O card is not connected"	This message is displayed if the main control board has lost communication with the I/O card.(both while cycle is running or not).	Turn the unit off and then back on. If the message reappears Call for service
"Low Temp"	This message is displayed if the temperature drops below the sterilization temperature for more than 1 second during sterilization cycle.	Perform a new cycle. The chamber may be overloaded, remove some material from the chamber. Check for steam leakage around the door. Clean or replace the door gasket if necessary. If the problem persists, call for service
"High Temp"	This message is displayed if the temperature raises 5.4°F (3°C) above sterilization temperature during the sterilization stage for 2 seconds during sterilization cycle.	Perform a new cycle. If the problem persists, call for service.
"High Temp. (Ending)"	This message is displayed if the chamber cannot reach the required ending temperature within 10 minutes.	Verify that the autoclave is not overloaded. Remove some material from the chamber Perform a new cycle. If the problem persists, call for service.
"Heat Time Error"	This message is displayed if the chamber cannot reach the required temperature within the preset time.	Verify that the autoclave is not overloaded, remove some material and perform another cycle. The atmospheric pressure parameter may need to be set. See section 5.2.3.1. If the problem persists, call for service.

Problem/ Error Message	Message / Symbol Description	Corrective Action
"Heat Time Error (Keep)"	This message is displayed if the system cannot reach the required temperature, in the chamber, during the optional "Keep Heat" stage, within the preset time.	Perform a new cycle. The chamber may be overloaded, remove some material from the chamber. If the problem persists, call for service.
"Low Pressure"	This message is displayed if Chamber Pressure drops below the sterilization pressure for 2 seconds during the sterilization stage.	Perform a new cycle. The chamber may be overloaded, remove some material from the chamber. Check for steam leakage around the door. Clean or replace the door gasket if necessary. If the problem persists, call for service.
"High Pressure"	This message is displayed if Chamber Pressure raises 4.2 psi (29 kPa) above sterilization pressure for 2 seconds during the sterilization stage.	Perform a new cycle. If the problem persists, call for service.
"High Pressure (Ending)"	This message is displayed if the system cannot reach atmospheric pressure ± 0.74 psi (5kPa) during the ending stage.	Wait until the chamber reaches the normal temperature range. If this takes more than 5 minutes call for service.
"High Pressure (Exhaust)"	This message is displayed if the system cannot reach preset pressure within 10 minutes from the beginning of the exhaust stage.	Reset the atmospheric pressure parameter See section 5.2.3.1. Perform a new cycle.
"High Pressure (Dry)"	This message is displayed if the pressure in chamber exceeds atmospheric pressure by more than 10kPa at the beginning of the dry stage.	Reset the atmospheric pressure parameter See section 5.2.3.1. Perform a new cycle.
"Pressure Time Error"	This message is displayed if the system cannot reach the required pressure conditions in the chamber, after preset time, during the air removal stage.	Perform a new cycle. The chamber may be overloaded, remove some material from the chamber. The atmospheric pressure parameter may need to be set. See section 5.2.3.1. If the problem persists, call for service.

Problem/ Error Message	Message / Symbol Description	Corrective Action
"RTC Error - Please Set Current Date and Time"	This message is displayed in order to set the date and the time.	Set Current Date and Time. If the problem persists, call the technician.
"Time Error"	The Date and Time have not been set.	Set current Date And Time. See sec. 5.1.6
	This message is displayed if the real time clock is faulty.	Call for service.
"Door is open (During the cycle)"	This message is displayed during the cycle if the door is open or the door switch is faulty.	Close the door more forcefully and perform a new cycle. If the problem persists, call for service.
"Canceled By User"	This message is displayed any time the START/STOP key is pressed after the cycle has started, the cycle will be aborted.	Wait until "cycle failed – canceled by user" or "cycle end – canceled by user" is displayed. Press the START/STOP key to clear the error message and perform a new cycle.
"Cycle Failed" 	This message and symbol are displayed if an error occurs before sterilization cycle is completed.	Press the START/STOP key to clear the error message then perform a new cycle. If the problem persists, call for service..
"Test Failed" 	This message and symbol are displayed if an error occurs before test cycle is completed.	Press the START/STOP key to clear the error message then perform a new cycle. If the problem persists, call for service.
"Air Error"	This message is displayed at the end of the cycle if the autoclave does not reach the atmospheric pressure after 10 minutes.	Wait until the autoclave reaches the atmospheric pressure. Reset the atmospheric pressure. If the problem does not correct itself call for service
"Jacket is cool"	The message is displayed if, when pressing Start/Stop, the temperature of the jacket is below the preset temperature.	Wait until the jacket warms up.
"Periodical check time exceeded - Please call for service"	The periodical maintenance time has passed.	Call for service.

Problem/ Error Message	Message / Symbol Description	Corrective Action
"Mineral free water reservoir empty"	This message is displayed if the water level electrode does not sense water.	Fill the mineral free water reservoir. If the reservoir is full then turn the unit off and back on.
	The water level electrode is faulty.	Call for service
"Cycle counter exceeded - Please call for service"	Number of cycles, since last periodical maintenance, exceeded the preset number as defined by "cycle counter" parameter.	Call for service.
"Power Down"	This message is displayed if a power down has occurred during the cycle. The printer will print "Power Down" when power is restored.	Check that the On/Off switch is not off Check that the power cord is plugged into the wall outlet and the back of the machine Check that there is power at the wall outlet. Perform a new cycle when power is restored
	This icon is displayed when the mineral free reservoir needs water.	Fill the mineral free reservoir with steam distilled water
	This symbol is displayed when the waste water reservoir is full.	Drain the waste water reservoir by plugging the included drain tube into the waste water drain. (see front view)
Door gasket makes a high pitched whistle or crackling sound	Door is not closed properly.	Open door and close it more forcefully.
	Door gasket is dirty.	Clean the door gasket.
	Door gasket needs to be replaced.	Replace door gasket using silicone lubricant.
	Lubricant was not used properly when door gasket was replaced.	Remove gasket and clean off excess lubricant. Reinstall using proper amount of lubricant.
Water under the sterilizer	Reservoir is over filled. The reservoir has an overflow and excess water in the reservoir will drain through the overflow on to the counter below the sterilizer.	Don't fill while a cycle is running. Don't fill above the blue area on the Front Fill Funnel. If the reservoir is overfilled drain excess water by using the front drain.

12. SPARE PARTS LIST

PART NUMBER	DESCRIPTION
FIL175-0042	Filter, Air, 0.2 Micron
THE002-0003	Printer Paper 10 pack

13. ACCESSORIES

PART NUMBER	DESCRIPTION
CMT240-0097	Handle, Tray
THE002-0052	Printer, PLUSII-S2B-0004
TRH411-0021	Holder, Tray
TRY254-0003	Tray
WIR040-0005	Power cable 16A
AR910	Elara11 Pouch rack
GAS083-0004	Drain silicone Tube, 7x13
VLV170-0014	Drain connecter male

POUCH RACK AR910



TRAY HANDLE CMT240-0097



TRAY TRY254-0003



TRAY HOLDER FOR EZ11PLUS TRH411-0021

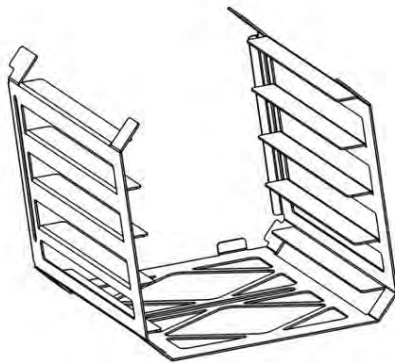

Drain Tube GAS083-0004



GAS083-0004

Drain Tube connector VLV170-0014



VLV170-0014

Air filter FIL175-0042



FIL175-0042